

P1200 Standard POS Printer

Thermal Printer

User Manual

01750352498B



Table of Contents

1	MANUFACTURER'S DECLARATION AND APPROVAL	1-1
2	SUPPLIER'S DECLARATION OF CONFORMITY	2-1
3	SAFETY SUMMARY	3-1
4	IMPORTANT INFORMATION TO THE USER	4-1
5	UNPACKING	5-1
6	PRODUCT OVERVIEW	6-1
6.1	Introduction	6-1
6.2	Features	6-1
6.3	Applicable Model	6-2
6.4	Accessories	6-2
7	SPECIFICATIONS	7-1
7.1	General	7-1
7.2	Environmental usage conditions	7-3
7.3	Internal buffers	7-4
7.4	Thermal head basic performance	7-4
7.5	Main Card	7-4
7.6	Option Interface Card	7-5
7.7	Reliability	7-5
7.8	Options	7-6
7.9	Paper Roll	7-7
8	APPEARANCE	8-1
8.1	Front/Rear View	8-1
8.2	LED and Feed Button	8-1
8.3	Power Button	8-2
8.4	Connectors	8-3
8.5	Specification of Interface & Power Connector	8-4
8.5.1	RS232 Interface	8-4
8.5.2	Ethernet Interface	8-5
8.5.3	Power USB Interface	8-6
8.5.4	USB Interface	8-7
8.5.5	Power Cable Connector	8-8
8.5.6	Cash Drawer Connector and Pin Assignments	8-9
9	SET UP PROCEDURE	9-1
9.1	Requirements for Operation	9-1
9.2	Setting up the Printer	9-3
9.3	Turning off the Printer	9-4
10	INSTALLATION PROCEDURE	10-1
10.1	Connecting the Power Cord and Interface Cable	10-1
10.1.1	Connect to Power Adapter	10-2
10.1.2	Connect via standard USB Type-B Cable	10-2

10.1.3	Connect via Option Card (RS232 & LAN)	10-3
10.1.4	Connect via Y-Cable	10-4
10.1.5	Connecting via Cash Drawer	10-5
10.1.6	Interface cable to POS terminal connection position	10-5
10.2	Choosing a Location	10-6
10.3	Loading the Paper Roll	10-9
11	DIAGNOSTICS	11-1
11.1	Offline Diagnostic	11-1
12	GENERAL MAINTENANCE	12-1
12.1	Cleaning the Covers	12-1
12.2	Cleaning the Thermal Print Head	12-1
13	TROUBLESHOOTING	13-1
13.1	Removing Jammed Paper	13-1
13.2	Resetting Cutter Failure or Jam	13-2
13.3	Common Problems & Solutions	13-4
13.4	LED Indication Table	13-7
14	APPENDIX	14-1
14.1	Ethernet	14-1
14.2	Web Setting Page	14-1

1 MANUFACTURER'S DECLARATION AND APPROVAL



WARNING

This is a Class A product. In domestic environment, this product may cause radio interference in which user may be required to take adequate measures.

FCC-Class A Declaration

This equipment has been tested and found to comply with the limits for a Class A digital device, pursuant to part 15 of the FCC Rules. These limits are designed to provide reasonable protection against harmful interference when the equipment is operated in a commercial environment. This equipment generates, uses, and can radiate radio frequency energy and, if not installed and used in accordance with the instruction manual, may cause harmful interference to radio communications. Operation of this equipment in a residential area is likely to cause harmful interference in which case the user will be required to correct the interference at his own expense. Modifications not authorized by the manufacturer may void users authority to operate this device.

FCC Caution: Any changes or modifications not expressly approved by the party responsible for compliance could void the user's authority to operate this equipment.

This transmitter must not be co-located or operating in conjunction with any other antenna or transmitter.

CAN ICES-3 (A)/NMB-3 (A)



The device complies with the requirements of the EEC directive 2014/30/EU with regard to "Electro-magnetic compatibility" and 2014/35/EU "Low Voltage Directive" and RoHS directive 2011/65/EU.

Therefore, you will find the CE mark on the device or packaging.



In addition, the P1200 has received the cTUVus symbol.

The following information is for EU-member states only:

Disposal of products

(based on EU-Directive 2012/19/EU)

Directive on Waste electrical and electronic equipment – WEEE)



The use of the symbol indicates that this product may not be disposed as unsorted municipal waste and has to be collected separately. Integrated batteries and accumulators can be disposed of with the product. They will be separated at the recycling centers.



The black bar indicates that the product was placed on the market after August 13, 2005.

By ensuring this product is disposed of correctly, you will help prevent potential negative consequences for the environmental and human health, which could otherwise be caused by inappropriate waste handling of this product.

For more detailed information about the take-back and recycling of this product, please contact your supplier where you purchased this product.

Changes or modifications not expressly approved by the manufacturer for compliance could void the User's authority to operate the equipment.

2 SUPPLIER'S DECLARATION OF CONFORMITY

Product Description: Thermal Printer

Model: P1200

Party issuing Supplier's Declaration of Conformity

Diebold Nixdorf Singapore PTE. LTD.

30A Kallang Place

#04-01

Singapore 339213

Phone: +65 6747 3828

Responsible Party – U.S. Contact Information

Diebold Nixdorf

5995 Mayfair Road

N. Canton, OH 44720 / USA

Phone: +1 330 490 5049

FCC Compliance Statement (for products subject to Part 15)

This device complies with Part 15 of the FCC Rules. Operation is subject to the following two conditions:



- (1) This device may not cause harmful interference, and
- (2) this device must accept any interference received, including interference that may cause undesired operation.



3 SAFETY SUMMARY







Personal safety in handling or maintaining the equipment is extremely important. Warnings and Cautions necessary for safe handling are included in this manual. All warnings and cautions contained in this manual should be read and understood before handling or maintaining the equipment.

Do not attempt to effect repairs or modifications to this equipment. If a fault occurs that cannot be rectified using the procedures described in this manual, turn off the power supply, unplug the machine, and then contact your authorized Diebold Nixdorf representative for assistance.

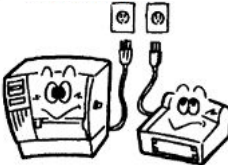









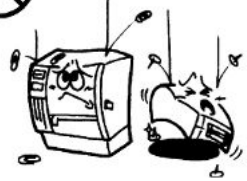

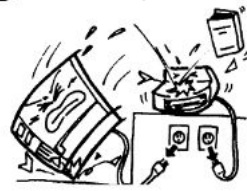

Meanings of Each Symbol

	<p>This symbol indicates warning items (including cautions).</p> <p>Specific warning contents are drawn inside the symbol.</p> <p>(The symbol on the left indicates a general caution.)</p>
	<p>This symbol indicates prohibited actions (prohibited items).</p> <p>Specific prohibited contents are drawn inside or near the symbol.</p> <p>(The symbol on the left indicates “no disassembling”.)</p>
	<p>This symbol indicates actions which must be performed.</p> <p>Specific instructions are drawn inside or near the • symbol.</p> <p>(The symbol on the left indicates “disconnect the power cord plug from the outlet”.)</p>

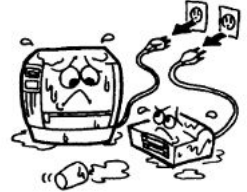
	 WARNING
<p>This indicates that there is the risk of death or serious injury if the machines are improperly handled contrary to this indication.</p>	

 <p>Any other than the specified AC voltage is prohibited.</p> 	<p>Do not use voltages other than the voltage (AC) specified on the rating plate, as this may cause fire or electric shock.</p>	 <p>Prohibited</p> 	<p>Do not plug in or unplug the power cord plug with wet hands as this may cause electric shock.</p>
 <p>Prohibited</p> 	<p>If the machines share the same outlet with any other electrical appliances which consume large amounts of power, the voltage will fluctuate widely each time these appliances operate. Be sure to provide an exclusive outlet for the machine as this may cause the machines to malfunction.</p>	 <p>Prohibited</p> 	<p>Do not place metal objects or water-filled containers such as flower vases, flower pots or mugs, etc. on top of the machines. If metal objects or spilled liquid enter the machines, this may cause fire or electric shock.</p>

SAFETY SUMMARY

 <p>Prohibited</p> 	<p>Do not insert or drop metal, flammable or other foreign objects into the machines through the ventilation slits, as this may cause fire or electric shock.</p>	 <p>Prohibited</p> 	<p>Do not scratch, damage or modify the power cords. Also, do not place heavy objects on, pull on, or excessively bend the cords, as this may cause fire or electrical shock.</p>
 <p>Disconnect the plug.</p> 	<p>If the machines are dropped or their cabinets damaged, first turn off the power switches and disconnect the power cord plugs from the outlet, and then contact your authorized Diebold Nixdorf representative for assistance. Continued use of the machine in that condition may cause fire or electric shock.</p>	 <p>Disconnect the plug.</p> 	<p>Continued use of the machines in an abnormal condition such as when the machines are producing smoke or strange smells may cause fire or electric shock. In these cases, immediately turn off the power switches and disconnect the power cord plugs from the outlet. Then, contact your authorized Diebold Nixdorf representative for assistance.</p>
 <p>Disconnect the plug.</p> 	<p>If foreign objects (metal fragments, water, and liquids) enter the machines, first turn off the power switches and disconnect the power cord plugs from the outlet, and then contact your authorized Diebold Nixdorf representative for assistance. Continued use of the machine in that condition may cause fire or electric shock.</p>	 <p>Disconnect the plug.</p> 	<p>When unplugging the power cords, be sure to hold and pull on the plug portion. Pulling on the cord portion may cut or expose the internal wires and cause fire or electric shock.</p>
 <p>Connect a grounding wire.</p> 	<p>Ensure that the equipment is properly grounded. Extension cables should also be grounded. Fire or electric shock could occur on improperly grounded equipment.</p>	 <p>No disassembling.</p> 	<p>Do not remove covers, repair or modify the machine by yourself. You may be injured by high voltage, very hot parts or sharp edges inside the machine.</p>

	<p style="text-align: center;">⚠ CAUTION</p> <p>This indicates that there is the risk of personal injury or damage to objects if the machines are improperly handled contrary to this indication.</p>
---	--

Precautions

The following precautions will help to ensure that this machine will continue to function correctly.

- Try to avoid locations that have the following adverse conditions
 - Temperatures out of the specification
 - Direct sunlight
 - High humidity
 - Shared power source
 - Excessive vibration
 - Dust/Gas
- The cover should be cleaned by wiping with a dry cloth or a cloth slightly dampened with a mild detergent solution. NEVER USE THINNER OR ANY OTHER VOLATILE SOLVENT on the plastic covers.
- USE ONLY DIEBOLD NIXDORF SPECIFIED paper.
- DO NOT STORE the paper where they might be exposed to direct sunlight, high temperatures, high humidity, dust, or gas.
- Ensure the printer is operated on a level surface or vertical wall..
- Any data stored in the memory of the printer could be lost during a printer fault.
- Try to avoid using this equipment on the same power supply as high voltage equipment or equipment likely to cause mains interference.
- Unplug the machine whenever you are working inside it or cleaning it.
- Keep your work environment static free.
- Do not place heavy objects on top of the machines, as these items may become unbalanced and fall causing injury.
- Do not lean against the machine. It may fall on you and could cause injury.
- Care must be taken not to injure yourself with the printer paper cutter.
- Unplug the machine when it is not used for a long period of time.

4 IMPORTANT INFORMATION TO THE USER

In order to ensure compliance with the Product Safety, FCC marking requirements, you must use the power supply, power cord, and interface cable which were shipped with this product or which meet the following parameters:

Power Adapter

The power adapter is required to comply with the safety and/or EMC requirements depending on the county where the equipment is used, and to have the following electrical characteristics, Class 1 power adapter with SELV (Secondary Extra Low Voltage), input rated 100-240 Vac, 2.0A Max, 50/60 Hz, output rated 24 Vdc, 2.6A.



Interface Cable

You are advised to use a shielded (360 degree) interface cable with this product. The shield must be connected to the frame or earth ground connection or earth ground reference at BOTH ends of the cable. If another cable is used than described above you will need to test this cable with the Diebold Nixdorf printer and your system for local EMC requirements where the equipment is used.

Power Cord

For this product a UL listed, detachable power cord is required. When the power supply is mounted on the floor, a power cord with Type SJT marking is required. If a power cord is used different from described above, you might violate safety certifications which are in force in the country of use. The socket-outlet needs to be installed near the equipment and must be easily accessible.

Caution Label Information / Informations sur l'étiquette d'avertissement

	Hot surface, Do not touch / Surface chaude, Ne pas toucher
	Hazardous Moving Parts, Keep Fingers and Other Body Parts Away/ Parties Mobiles Dangereuses Tenir Les Doigts Et Les Autres Parties Du Corps Éloignés.

Power Cord

As the power cord is not supplied with this printer, locally purchase the power cord that meets the following standard.

For USA and Canada:

Power Cord – UL and CSA approved, type SVT, 18/3AWG, rated min. 125V, 10A

Attached Plug and Appliance Coupler – UL and CSA approved, molded on type.

The plug is parallel-blade grounding type, NEMA 5-15P configuration. The appliance coupler is Female configuration.

Both attachment plug and appliance coupler are rated minimum 125V, 10A.

For European countries:

Power Supply Cord – HAR or domestic approved where the equipment is used,

Type H05VV-F, rated minimum 250V, 10A.

Attachment Plug and Appliance Coupler – Domestic approved where the equipment is used, molded on type, having grounding terminal rated minimum 250V, 10A. The appliance coupler is Female configuration.

5 UNPACKING

1. Open the carton.
2. Remove the printer from the carton.
3. Check the content and make sure no missing parts.
4. Place the printer on a level surface and make sure no physical damage.



Printer

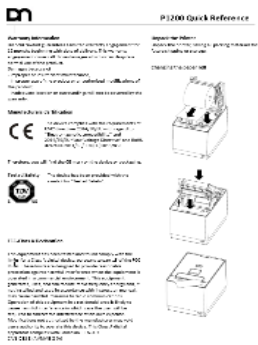

Quick Installation Manual



Starter Roll



Carton

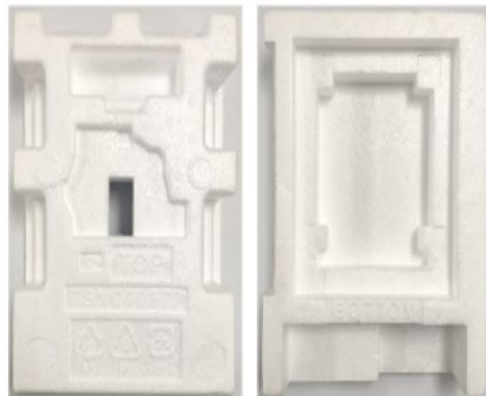

Protector Pack



NOTE

Keep the original carton and protector pack for future transportation of the printer.

6 PRODUCT OVERVIEW

6.1 Introduction

This product consists a thermal head for one side printing. Base model includes a 32bit CPU architecture with Flash ROM, Cash Drawer Connector, Mini-DIN Power, USB Type B connector and expansion connector. The expansion connector is compatible with Power USB I/F, and RS232 I/F or Ethernet I/F as option.

This manual contains general set-up and maintenance information and should be read carefully to help gain the maximum performance and life from your printer. For most queries please refer to this manual and keep it safe for future reference.

6.2 Features

Drop-in paper loading

Paper out sensor

Paper jam sensor (detecting initial jam of paper at platen roller)

Knife: Cut paper in full cut or partial cut (Partial cut knife leaves 2mm uncut at center).

It supports both detection at horizontal and vertical mount / wall mount orientation.

6.3 Applicable Model

Model name description

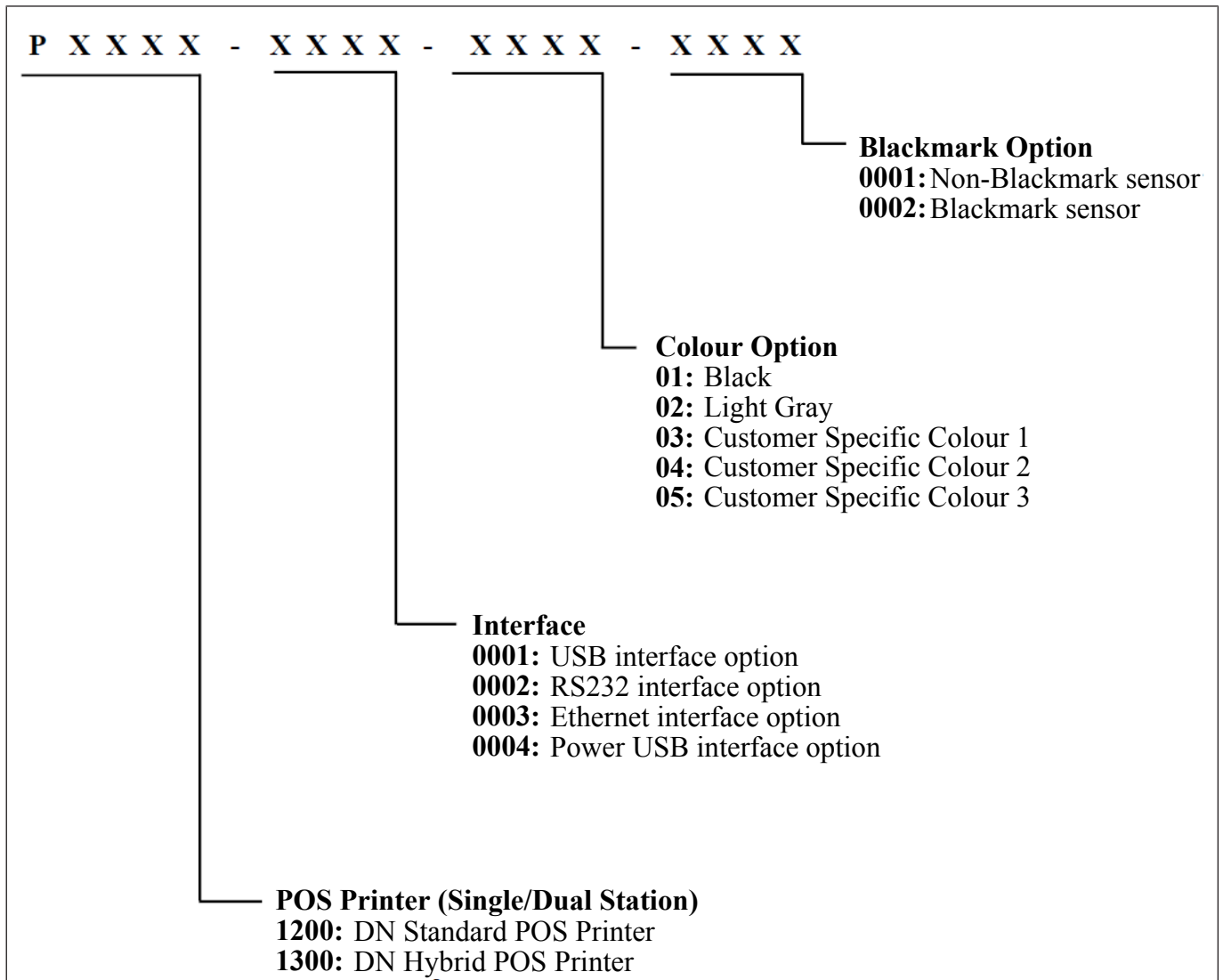

6.4 Accessories

The following accessories are packed in the shipping carton box as shown below:

1 unit of Printer enclosed in a plastic bag and protector pack

Starter Roll (1pcs)

Quick reference (1 copy)

7 SPECIFICATIONS

7.1 General

Resolution	203 dpi model: 203 dpi x 203 dpi (8 dots/mm)
Interface (USB Type-B)	USB 2.0 High Speed Printer Class
Emulation Mode	TH230 and ESP/POS
Character set	<p>437 (US), 720 (Arabic), 737 (Greek), 775 (Baltic), 850 (Multilingual), 852 (Latin II), 857 (Turkish), 858 (with Eurosymbol), 860 (Portuguese), 862 (Hebrew), 863 (French Canadian), 864 (Arabic), 865 (Nordic), 866 (Cyrillic), 874 (Thai), 1250 (Windows Central Europe), 1251 (Windows Cyrillic), 1252 (Windows Latin I), 1253 (Windows Greek), 1254 (Windows Turkish), 1255 (Windows Hebrew), 1256 (Windows Arabic), 1257 (Windows Baltic), 28591 (Windows Latin 1), 28592 (Windows Latin 2), 28594 (Windows Baltic), 28596 (Windows Arabic), 28599 (Windows Turkish), 28605 (Windows Latin 9), Katakana and KZ_1048(Kazakh)</p> <p>Asian character set:</p> <p>932 (Kanji), 949 (Korean), 936 (Simplified Chinese) and 950 (Traditional Chinese with HKSCS extension) and GB18030</p>
Receipt Printing Speed	<p>203 dpi model: Max. 355 mm/Sec (14 IPS)</p> <p>Printing speed is varied according to print density.</p>
Character attribute	Double width , Double high ,rotate , under line, bold
Bar code	UPC-A, UPC-E, EAN8, EAN13, Code 39, Code 93, Interleaved 2 of 5, Codabar, Code 128, EAN 128, GS1 Databar, Datamatrix, QR, and PDF-417
Gray scale printing	Print Speed 4ips max (101.6 mm/sec), 16 level gray scale
2 color printing	Print Speed 5ips max (127 mm/sec)
Line Spacing	7.52 LPI (default)
Resident Font - (It support two font types.)	
Character Cell Size	

SPECIFICATIONS

- Font A	13(H) X 24(V) dots	
- Font B	10(H) X 24(V) dots	
- Kanji	24(H) X 24(V) dots	
Column Width	80mm Paper mode	58mm Paper mode
- Font A	44 columns	31 columns
- Font B	57 columns	40 columns
- Kanji	24 columns	17 columns
Printable Width 2	80mm Paper mode	58mm Paper mode
- Font A	572 dots (71.50 mm)	403 dots (50.37 mm)
- Font B	570 dots (71.25 mm)	400 dots (50.00 mm)
- Kanji	576 dots (72.00 mm)	408 dots (51.00 mm)
- Graphics	576 dots (72.00 mm)	408 dots (51.00 mm)
Dimension	W 137 mm x H 138.5 mm x D 187 mm	
Weight	Approx. 1.3 Kg	

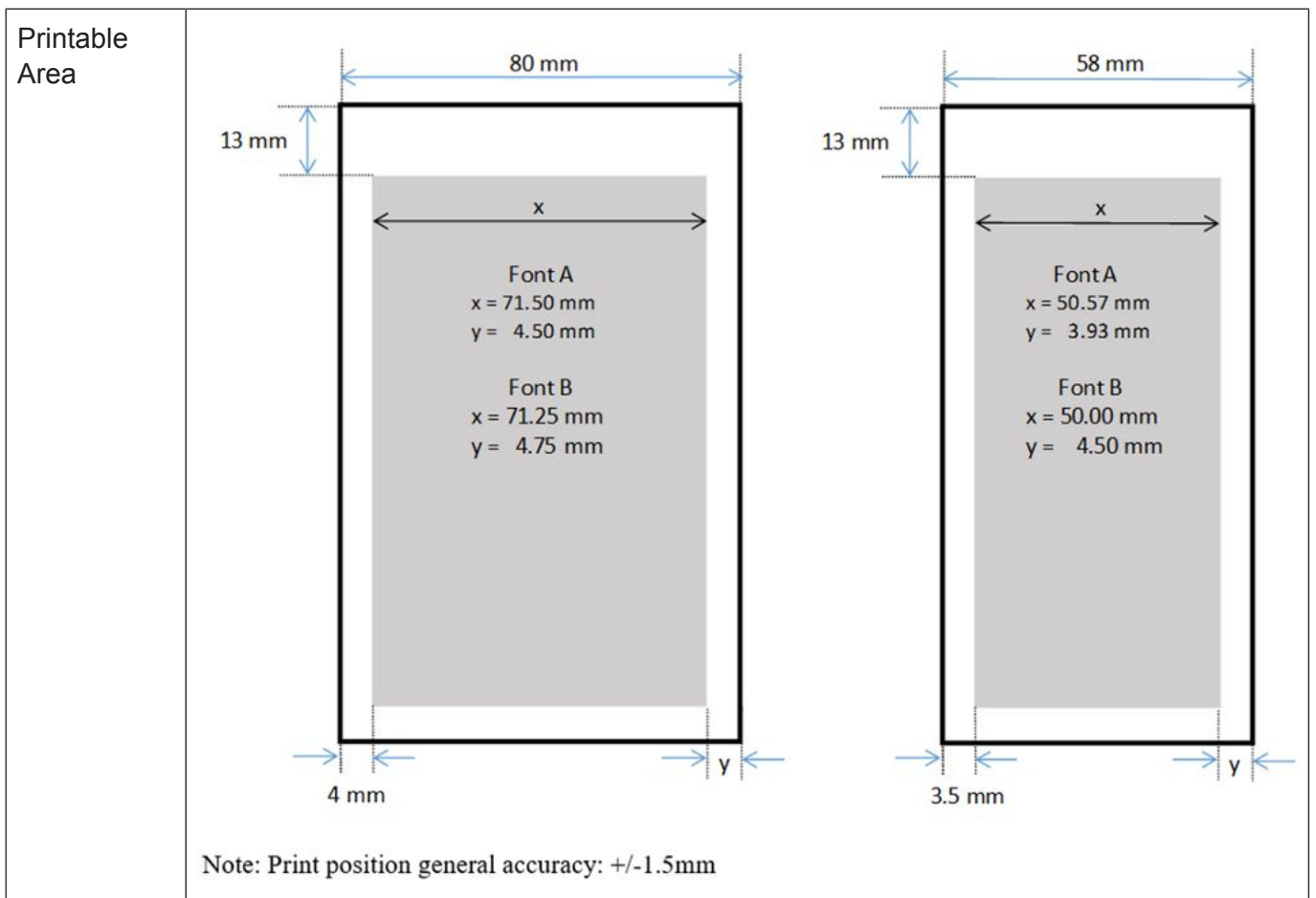

7.2 Environmental usage conditions

1) During normal operation

Temperature range : 0 - 50°C

Temperature change : Max. 10°C /hour

Humidity range (no condensation) : 5% - 90%

Temperature at dew point : Max. 26°C

Humidity change : Max.10% /hour (at 26°C)

2) In idle mode

Temperature range : 0 - 55°C

Temperature change : Max. 10°C /hour

Humidity range (no condensation) : 5 - 95%

Temperature at dew point : Max. 26°C

3) Extreme operating range

Temperature range : 0 - 55°C

Temperature change : Max. 10°C /hour

Humidity range (no condensation) : 10 - 90%

Temperature at dew point : Max. 45°C

4) Storage

Temperature range (Dry Bulb) : -10 - 55°C

Max. Temperature Change : 15°C/hour

Humidity range (no condensation) : 5% - 90%

5) Transit

Temperature range (Dry Bulb) : -40 - 60°C

Max. Temperature Change : 20°C/hour

Humidity range (no condensation) : 5% - 95%

7.3 Internal buffers

RAM (Total Size: IRAM 1.25MB, DRAM 8MB)

Interface Receive Data buffer 64 KB

Interface Send Data buffer 1 KB

User-defined Logo buffer 256 KB

Macro buffer 2 KB

Flash Memory (Total Size: 8MB)

User-defined Logo area 256 KB

User-defined Character area 64 KB

User-defined Data area 64 KB

Macro area 2 KB

7.4 Thermal head basic performance

- 1) Type : Line thermal
- 2) Number of heating elements : 640 dots
- 3) Dot density : 8 dots/mm
- 4) Effective recording width : 80.00 mm
- 5) Data transmission method : 2 serial I/O inputs.
- 6) Number of strobes : 2

7.5 Main Card

- 1) CPU : SH7267 (SH2A)
- 2) Operation Clock (CPU Internal) : 144 MHz
- 3) Program ROM : 64M bits Serial Flash ROM
(W25Q64JVSSIQ/TRAY or equivalent)
- 4) RAM : 64M bits SDRAM
(W9864G6KH-6 or equivalent)
- 5) I/F circuit : USB I/F (Type B)
- 6) Other I/F Connector : Cash Drawer Connector
- 7) Input : DC 24V Input
- 8) Indicator and SW : LED (Green, Red and Amber), Feed Button & Power Button

7.6 Option Interface Card

- 1) Option Interface board 1 : Serial RS232 I/F
- 2) Option Interface board 2 : Ethernet 10Base-t, 100Base-TX I/F
- 3) Option Interface board 3 : Power USB

* Only one optional interface card is available to integrate into the printer.

7.7 Reliability

2.7.1 Life

Thermal print head : 200 km (based on specified paper NPI TF50KS-EY)

Cutter : 3 million cuts (based on specified paper NPI TF50KS-EY)

2.7.2 Life MTBF (MCBF)

Printer : 70,000,000 Lines at 7.52lines/inch(MCBF)

MAIN PCB : 1,650,000 hours (Telcordia RPP, formerly Bellcore)

Interface PCB, RS232 I/F : 43,450,000 hours (Telcordia RPP, formerly Bellcore)

Interface PCB, Ethernet I/F : 26,300,000 hours (Telcordia RPP, formerly Bellcore)



Interface PCB, Power USB : XXXXXX hours (Telcordia RPP, formerly Bellcore)

Condition:

Above MTBF and MCBF has been confirmed under Normal environment (at 25°C)

The default line spacing is 7.52LPI.

7.8 Options

Option	Description
<p data-bbox="161 360 432 394">58mm Paper Guide</p> 	<p data-bbox="684 360 1334 394">A side guide which to support 58mm paper width.</p>
<p data-bbox="161 891 376 925">Serial Interface</p> 	<p data-bbox="684 891 1461 958">Serial Interface is used to transmit data from the network to your computer by using RS232 cable.</p>
<p data-bbox="161 1366 456 1400">Power USB Interface</p> 	<p data-bbox="684 1366 1509 1433">Power USB Interface is used to transmit data from the network to your computer by using Power USB cable.</p>
<p data-bbox="161 1841 416 1874">Ethernet Interface</p>	<p data-bbox="684 1841 1501 1908">Ethernet Interface is used to transmit data from the network to your computer by using Ethernet cable.</p>

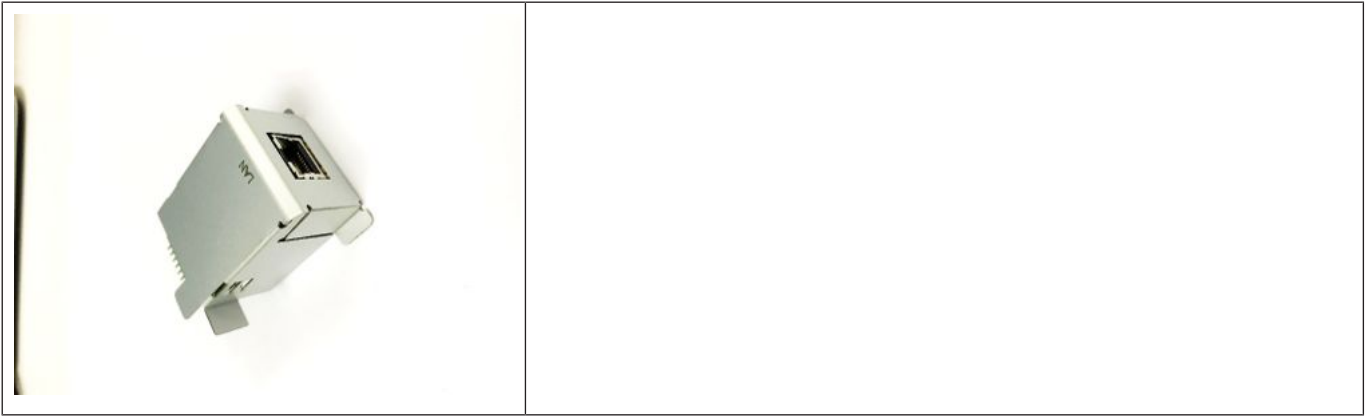

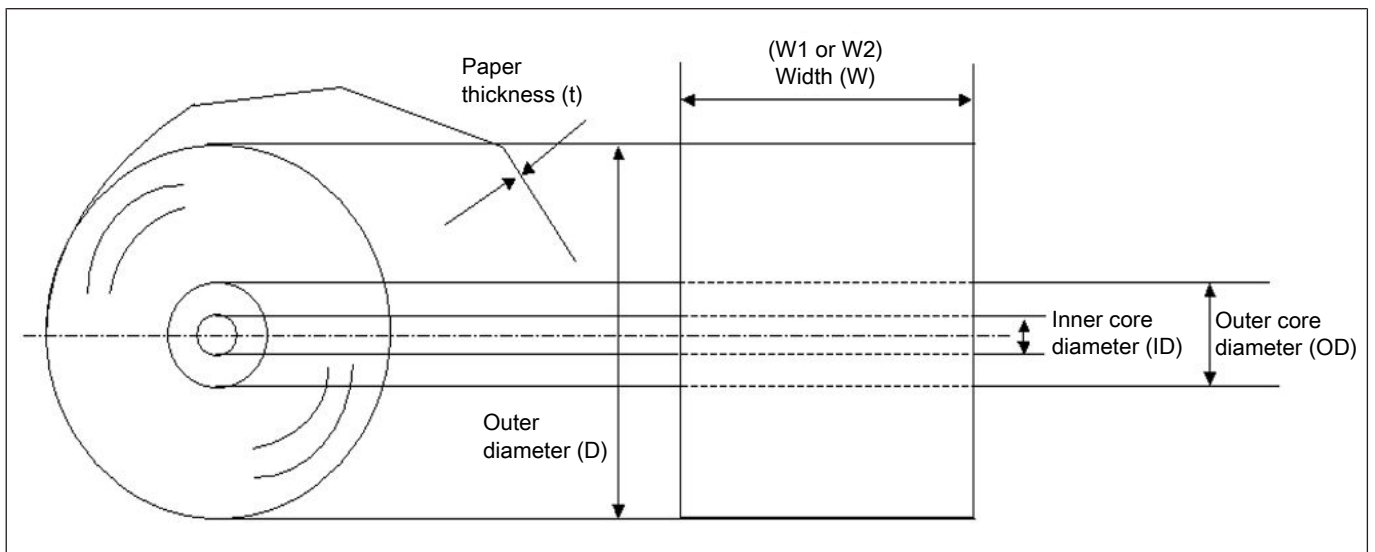

7.9 Paper Roll

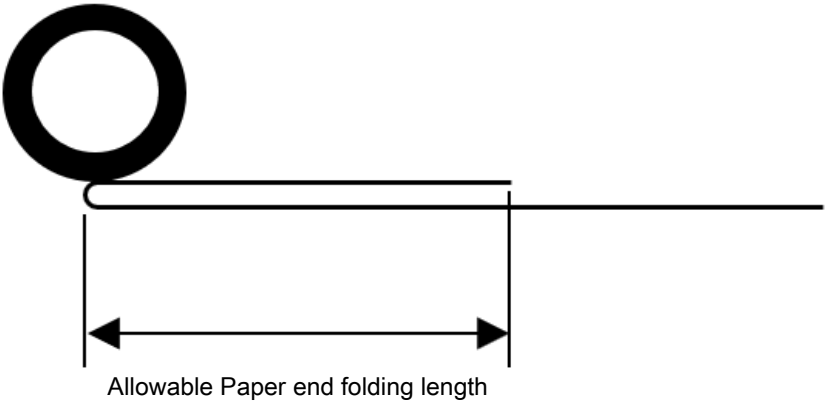

Paper type	Thermal paper rolled with the print side facing outside
Width (W1)	80 +0/ -1.0 mm
Width (W2)	58 +0/ -1.0 mm (With optional 58 mm paper guide)
Outer diameter (D)	90mm max
Paper thickness (T)	0.050 ~0.01 mm
Weight	48~80 g/m2
Recommended thermal paper	<p>Paper roll with inner core diameter 12mm is recommended and the paper end should not be pasted to the core. Recommend to use the following thermal paper for this product</p> <p>Paper Mode 0 Paper type : NPI TF50KS-EY Manufacturer : Nippon Paper Industries Energy required to achieve OD 1.1 : 0.25mJ/dot (information from paper specification) BPA Free : No</p>

SPECIFICATIONS

	<p>Paper Mode 1 Paper type : KT 48 FA Manufacturer : Koehler Energy required to achieve OD 1.1 : 14.9mJ/mm (information from paper specification) BPA Free : Yes</p> <p>Paper Mode 2 Paper type : KT 48 PF Manufacturer : Koehler Energy required to achieve OD 1.1 : 0.28mJ/dot (information from paper specification) BPA Free : Yes</p> <p>Paper Mode 3 Paper type : Blue4est Manufacturer : Koehler Energy required to achieve OD 1.1 : 0.27mJ/dot (information from paper specification) BPA Free : Yes</p>
<p>Allowable paper end folding length. (This refers to the fold length before winding the paper.)</p>	<p>< 30mm</p> 

	<p>⚠ CAUTION</p> <p>Use only paper which meets specified requirements. Use of non-specified paper may shorten the head life of the printer, resulting in problems with print quality, and cause a paper feed failure or shorten the cutter life. All paper should be handled with care to avoid any damage to the paper. Read the following guideline carefully.</p>
---	---

SPECIFICATIONS

Do not store the paper for longer than the manufacturer's recommended shelf life.

Store the paper in a cool, dry place. Avoid areas where they would be exposed to direct sunlight, high temperature, high humidity, dust or gas.

A contact of chemical or oil may discolor or erase the printed record.

Rubbing the paper hard with nail or hard object may discolor the paper.

The paper end should not be pasted to the core.

For further information, please contact to authorized paper manufacturer.

8 APPEARANCE

8.1 Front/Rear View

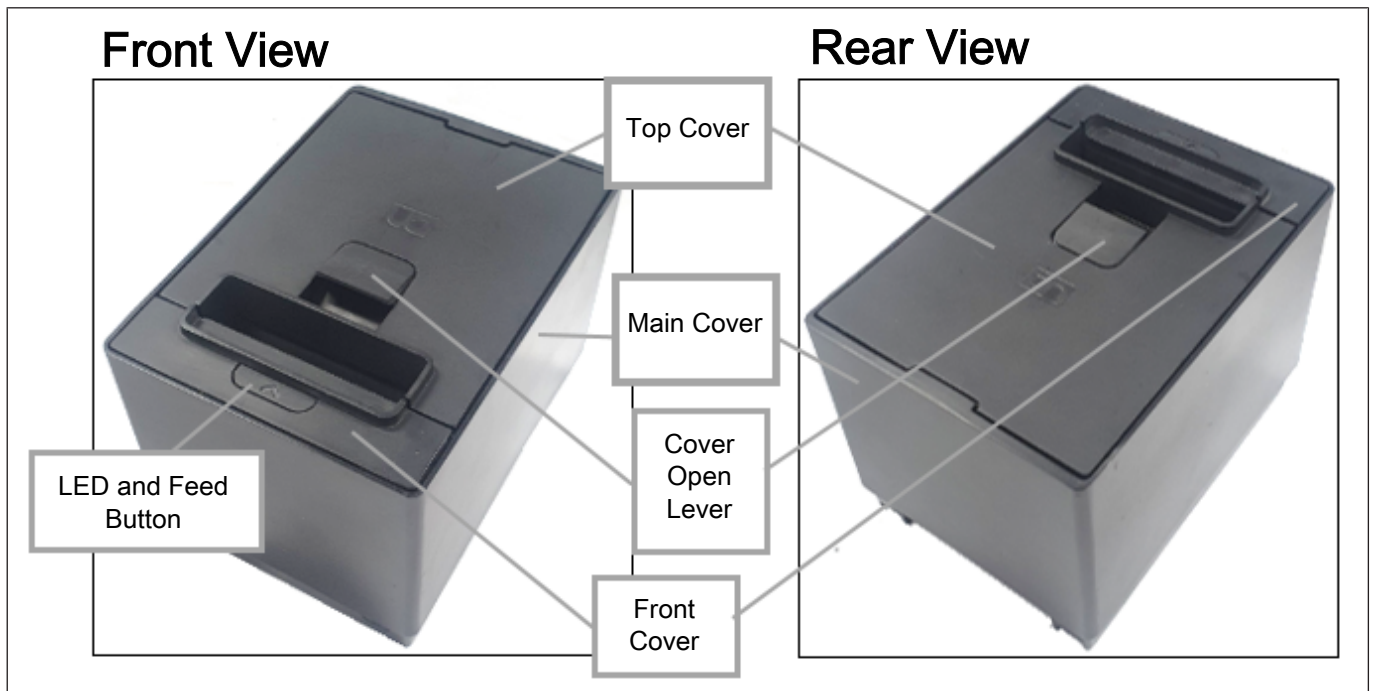

Top Cover — Open this cover to load paper

Cover Open Lever — Lift this lever to open top cover

Paper Feed Button — Press this button to feed paper or to change printer settings

Printer Status LED — Indicates status and error of printer (Red, Green and Amber)

8.2 LED and Feed Button

POWER LED (Amber/Green)

Amber light when the power supply is turn on. Green light when the print is ready to print.

ERROR LED (Red)

The Error LED indicates an error by showing different blinking patterns. Please refer to [Section 13.4](#) for more information.

FEED BUTTON

APPEARANCE

Used to feed receipt paper. A press on this button causes one line feed. While pressing and holding, it feeds the paper continuously. While the printer cover is opened, press and hold the feed button until the printer first beeps. Close the cover and the printer will enter offline diagnostic mode.



POWER LED (Amber/Green)

Amber light when the power supply is turn on. Green light when the print is ready to print.

ERROR LED (Red)

The Error LED indicates an error by showing different blinking patterns. Please refer to Section “LED Indication Table” for more information.

FEED BUTTON

Used to feed receipt paper. A press on this button causes one line feed. Pressing and holding it feeds the paper continuously. While the printer cover is open, press and hold the feed button until the printer first beeps. Close the cover and the printer enters offline diagnostic mode.

8.3 Power Button

POWER BUTTON

Pressing this button to switch on machine and after installed power connector.



Pressing this button more than 5 seconds to turn off machine.



POWER BUTTON

Pressing this button to switch on machine and after installed power connector.
Pressing this button more than 5 seconds to turn off machine

8.4 Connectors

	 CAUTION
<p>The drawer interface connector is exclusively for connecting the drawer. Do not connect a phone line or any other cables than the drawer cable to this connector. Doing so may cause a failure of the phone line and this printer.</p>	

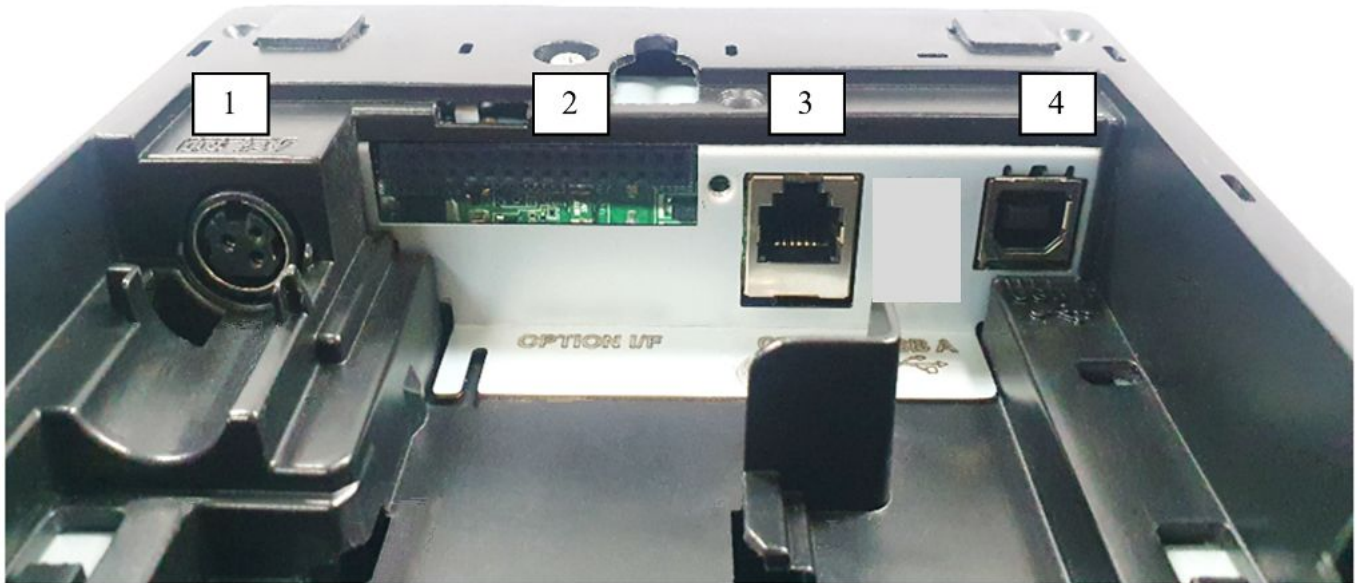

1. [DC24V] (Power connector)

The external power adapter supplies +24V power to the printer through this connector. Further information can refer to [Section 7.8](#) and [Section 8.5.5](#)

2. [Serial, Power USB or Ethernet interface connector] (Option)

A connector, which needs an interface cable connecting the printer to a POS terminal. A RS232 interface cable (Serial I/F model), Power USB cable (Power USB model) or an Ethernet interface cable "Ethernet I/F model" is need for this connector. Further information can refer to [Section 8.5.1](#), [Section 8.5.2](#) and [3.5.3 "Power USB Interface"](#).

3. [Drawer interface connector] (6 pin modular connector)

A drawer cable, which connects the printer to a drawer, is connect to this connector. Do not connect anything other than the connectable drawer. Further information can refer to [Section 9](#)

4. [USB Type-B interface connector]

A connector, which needs an interface cable connecting the printer to a POS terminal. An USB I/F (V2.0 Full Speed) is need for this connector. Further information can refer to [Section 8.5.3](#)

8.5 Specification of Interface & Power Connector

8.5.1 RS232 Interface

RS232C option I/F is transmitted through the full duplex serial port. The specification is as follows.

- 1) Baud Rate : 115200, 57600, 38400, 19200, 9600 bps
- 2) Data transfer protocol : DTR/DSR or XON/XOFF
- 3) Parity Bits : Non-parity, Even parity or Odd parity
- 4) Data Length : 7 bits or 8 bits
- 5) Stop Bits : 1 bit or 2 bits
- 6) Connector Pin Assignment

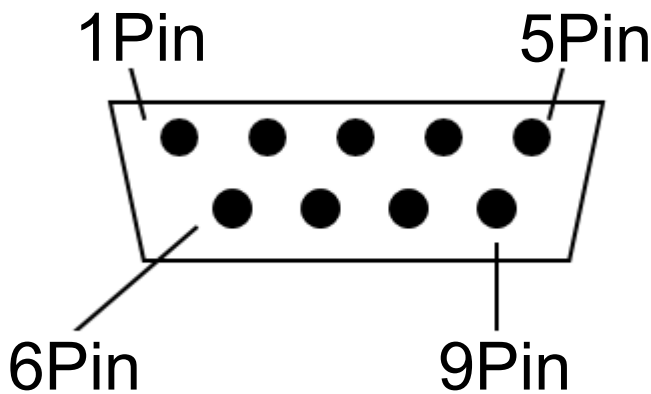

Serial I/F connector is 9pin D-SUB Male type connector with the following pin assignments:

Pin Number	Pin Function
1	Not Used
2	RXD
3	TXD
4	DTR
5	Logic GND
6	DSR
7	RTS
8	CTS
9	Not Used

8.5.2 Ethernet Interface

The specification of Ethernet option I/F is as follows.

- 1) Standard: Fully Compliant with IEEE 802.3u Standard (10BASE-T/100BASE-TX), support auto MDIX
- 2) Speed: Auto Negotiation: 10Mbps/100Mbps, Full/Half Duplex
- 3) Connector Pin Assignment

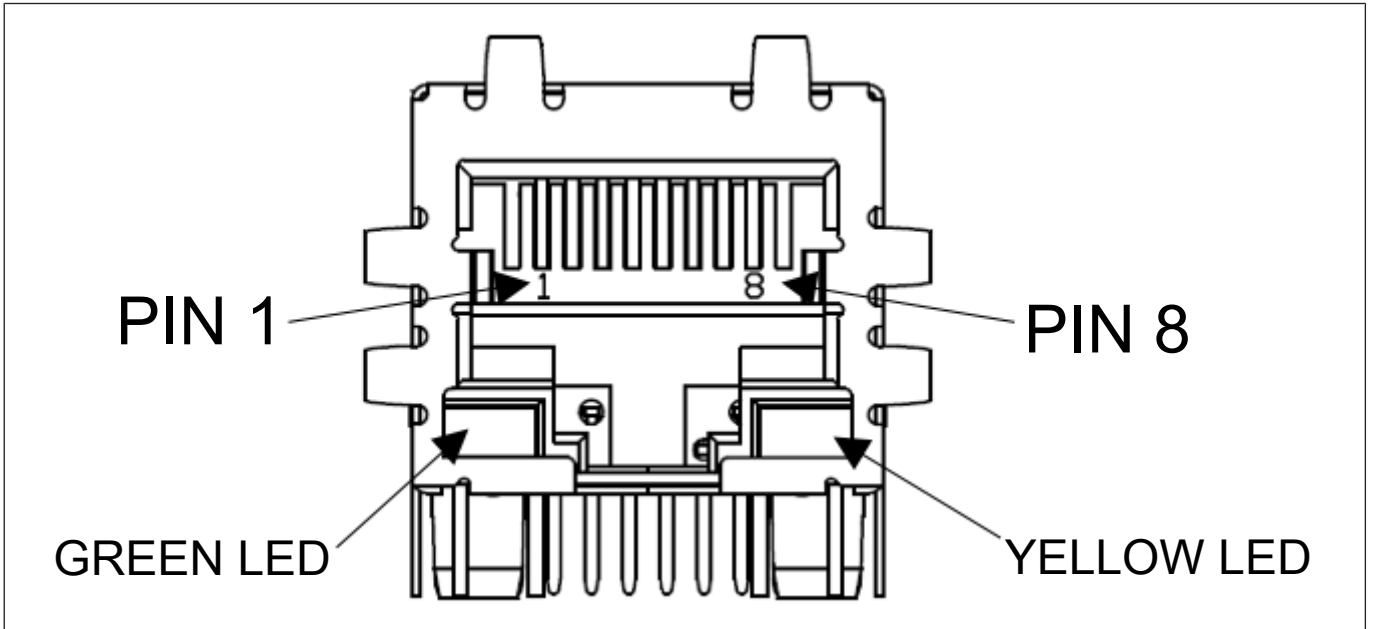

Ethernet connector type on printer side is POWERWAY 7588AS-B214-2000-D22-B1B.

LED indicators defined as follows:

Pin Number	Pin Function
1	TX+
2	TX-
3	RX+
6	RX-

	ON	OFF
GREEN	LINK/ACT	LINK
YELLOW	100BT	ACT

Link (up) = LED On; Activity = LED Blink; Link/Act = LED On/
Blink;
Speed = LED On (100BASE-T); LED Off (10BASE-T)

8.5.3 Power USB Interface

The Power USB connector on PCB is CONQUEST TECHNOLOGY 351005-7 or FCI 69913-104LF (or equivalent)

Connector Pin assignment:

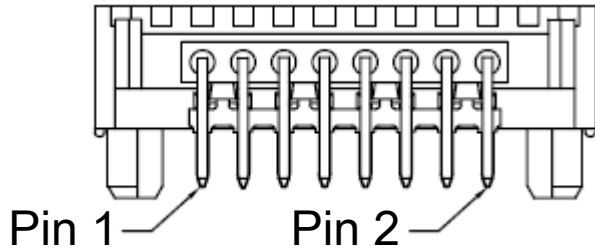

Pin Number	Pin Function
1	24V GND
2	+ 24V
3	GND
4	D +
5	D -
6	VBUS (+5V)
7	+ 24V
8	24V GND
SHELL	SHIELD

8.5.4 USB Interface

USB I/F is mounted on main card as default.

1) USB Version : Version 2.0 High speed

2) Connector Pin Assignment

The USB I/F connector is “B” Plug type for Device function. And “A” Plug type for Host function.

Type B connector

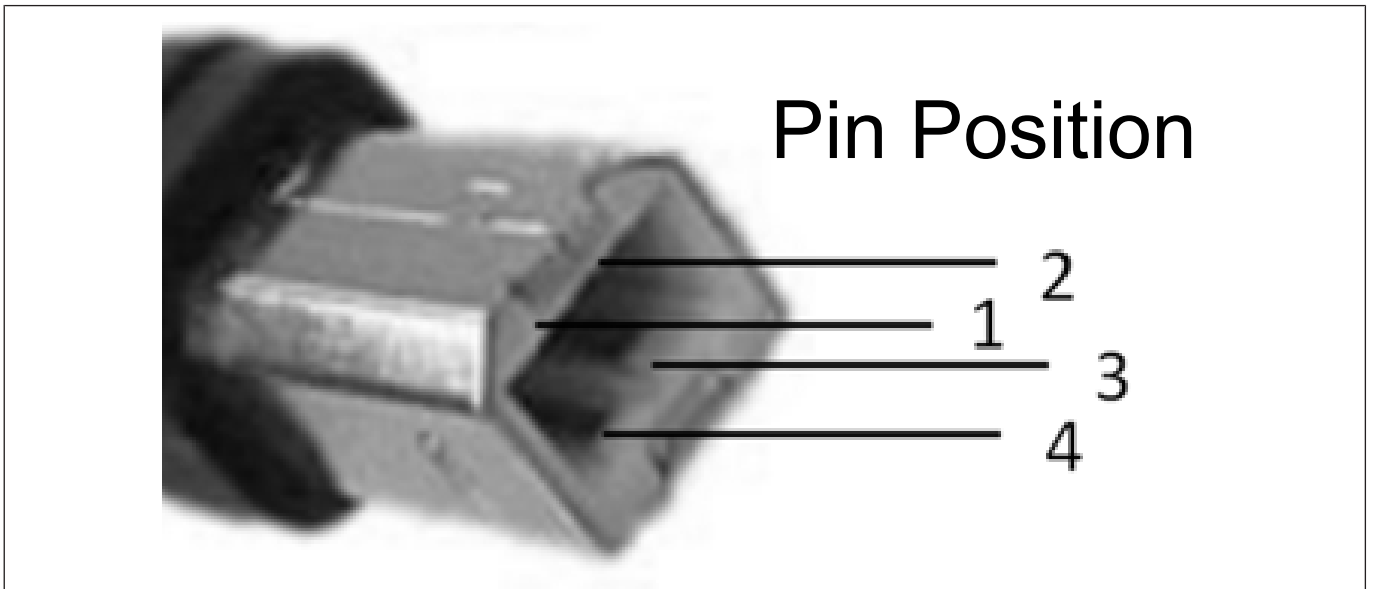

1	VBUS
2	D-
3	D+
4	GND
Shell	Shield

8.5.5 Power Cable Connector

The control cards received 24VDC +/-10% power via a 3 pin Mini-DIN plug, which mates with an integral shielded cable from power supply unit.

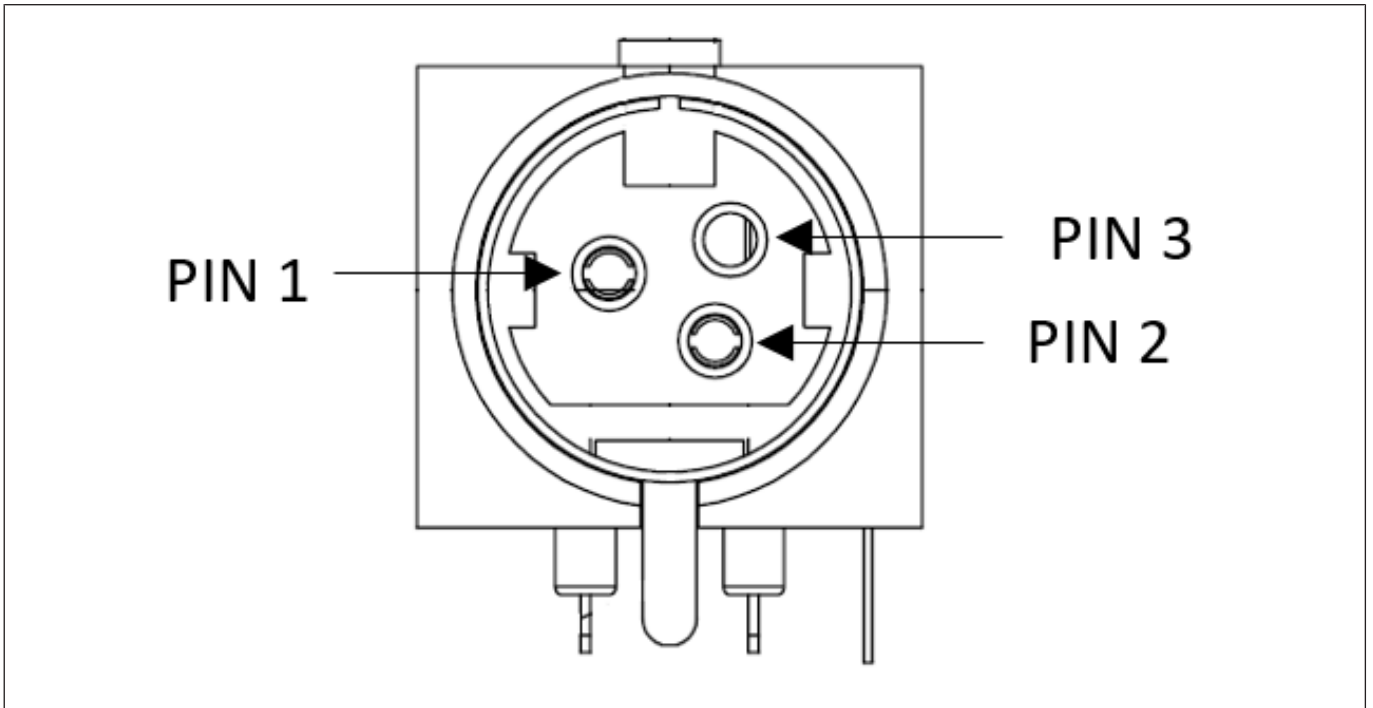

The power connector is WIESON GA1009-3AT1N1 (Or equivalent) with the following pin out:

Pin Number	Pin Function
1	+24VDC
2	Power Ground
3	PID
Shell	Frame Ground

Power ID pin (3) is used to detect the resistance from power source and set the power mode automatically.

Resistance Value on Power ID Pin	Power
1250 ~ 2125	48 W
2126 ~ 2625	55W
2626 ~ 3415	75 W
3416 ~ 4165	90 W
4166 ~ 8333	110 W
<1250 or >8333	75 W

8.5.6 Cash Drawer Connector and Pin Assignments

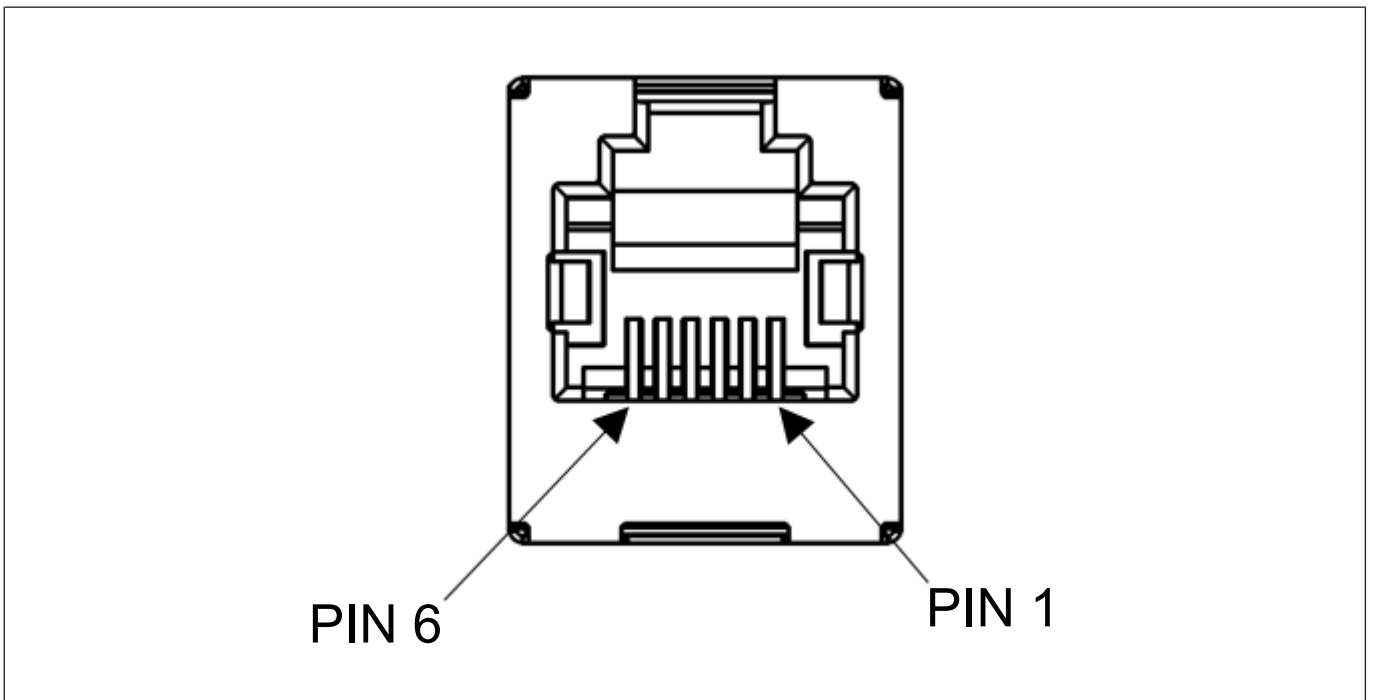

The Cash drawer connector is 6pin RJ12 Shielded type connector with the following pin assignments:

Pin Number	Pin Function
1	Frame GND
2	Drawer 1 Solenoid
3	Drawer 1 and 2 Status Switch
4	+24 Volts (to Solenoid)
5	Drawer 2 Solenoid
6	GND

9 SET UP PROCEDURE

9.1 Requirements for Operation

This printer needs the following requirements for communication and power:

Serial Interface Type

The POS terminal to be connected must have a Serial port.

To communicate with the POS terminal, an RS232 interface cable is required. Further information can refer to [Section 8.5.1](#)

Ethernet Interface Type

The POS terminal to be connected must have an Ethernet port.

To communicate with the POS terminal, an Ethernet interface cable is required. Further information can refer to [Section 8.5.2](#)

USB Interface Type

The POS terminal to be connected must have an USB port.

To communicate with the POS terminal, a USB cable is required. Further information can refer to [Section 8.5.3](#)

Power Supply

To supply power to printer with Power adapter (Option), or use Y cable (Option) to supply power from POS terminal to printer through power connector or USB connector, refer to [Section 8.5.5](#)

*To prevent the emission and receipt of electrical noise, the interface cable must meet the following requirements:

Fully shielded and fitted with metal or metalized connector housings.

Kept as short as possible.

Should not be tightly bundled with the power cord.

Should not be tied to power line conduits.

Power Mode



The printer supports 5 power modes as below:

Resistance Value on Power ID Pin	Power
1250 ~ 2125	48W
2126 ~ 2625	55W
2626 ~ 3415	75W
3416 ~ 4165	90W
4166 ~ 8333	110W
<1250 or >8333	75W

The printer power setting will be adjusted automatically via the power ID resistance measurement. For PUSB, the maximum power available is 75W.

The P1200 printer will both be set to the “Auto” power setting. The firmware will measure the resistor and set the power setting according to the table above.

Limiting of power consumption can also be adjusted via firmware setting.

	 CAUTION
	Motor may stall if the printer is connected to non Diebold Nixdorf qualified power supply where max power is lower than 75W and without power ID.

The mode should be adjusted accordingly basing on the source of power. Refer to [Section 11.1](#) for more information.

Power Saving

The printer is certified to the Energy Star Requirements as defined by the “*ENERGY STAR® Product Specification for Imaging Equipment, Version 3.0*”. Refer to [Section 9.3](#) for more information.

9.2 Setting up the Printer



CAUTION

1. Place the printer on a flat, stable surface.
2. Do not place the printer close to a heater or where it may be exposed to direct sunlight.
3. Avoid locations where the printer may be exposed to high temperature, high humidity or dust.
4. Care must be taken that no condensation occurs in the printer. If it should, however, do not turn ON the power supply until the condensation is dried.
5. Use a grounded electrical outlet. Do not use an adapter plug.
6. Be sure that there is adequate room around the printer for easy operation and maintenance.
7. Keep your work environment static free.

- 1) Make sure that the printer does not connect to power supply.
- 2) Connect the adapter cable to the printer.
- 3) Insert the power cord into the AC inlet.
- 4) Connect the interface cable to a POS terminal, and plug in the power cord to the AC outlet.
- 5) If a drawer is desired to be connected, connect the drawer interface cable to the printer.
- 6) Secure the drawer ground wire to the ground terminal on the rear of the printer.
- 7) Turn the printer power ON by switching on the power supply.
- 8) Open the printer cover.
- 9) Load the paper roll into the printer.
- 10) Close the printer cover.
- 11) Check the print quality by performing an Offline Diagnostic.
- 12) Install the printer driver given into POS terminal.
- 13) Connect the interface cable to the printer and the POS terminal.

Now the printer is ready for printing.

NOTES:

1. For details of the above steps 1) to 4), refer to [Section 10.1.1](#) [Section 10.1.2](#) and [Section 10.1.3](#)
2. Steps 5) and 6) are the procedures of the drawer connection. For details of Steps 5) and 6), refer to [Section 10.1.5](#)
3. For details of Steps 8) to 10), refer to [Section 10.3](#)
4. For details of Step 11), refer to [Section 11](#)

9.3 Turning off the Printer

- 1) Press and hold the power button for 5 seconds.
- 2) LED light will turn off indicates the printer is turned off.
- 3) To turn on the printer, press the power button again and the LED will light up.
- 4) Power can be switched off by sending command. Please refer to P1200 programming guide.

10 INSTALLATION PROCEDURE



WARNING

Since the power cord and the interface cable are not provided with this unit, please locally purchase ones that meet the specifications. For detail specifications, please contact the nearest authorized seller representative.

Before connecting the power cord and cables to the printer, please turn off the power supply of the POS terminal and the printer.

Do not pull the power cord hard. Doing this may damage the power cord, causing fire, electric shock, or broken wire.

When it thunders, unplug the power cord. Lightning stroke may cause fire or electric shock.

Keep the power cord away from a heater. The cover of the power cord may be melted, causing fire or electric shock.

Do not connect the power cord to the AC outlet provided on the POS terminal.



CAUTION

The recommended power adapter is exclusively for this printer. Do not use it for any other machines.

The power adapter can be used indoors only. Never use it outdoors.

Be sure to unplug the printer when it is not used for a long time.

Do not share the power source with other electric appliances which generate noise.

10.1 Connecting the Power Cord and Interface Cable



CAUTION

Be sure to hold the connector when plugging in or unplugging the power adapter cable.

Insert the power adapter cable and the power cord firmly.

10.1.1 Connect to Power Adapter

Insert the power cable into the power connector.



10.1.2 Connect via standard USB Type-B Cable

Connect USB Type-B is to link the printer to the POS Terminal.



10.1.3 Connect via Option Card (RS232 & LAN)

Remove the screw to detach the option metal cover in order to install the option cards. Remove the other screw also as this will be used to secure the option assembly.

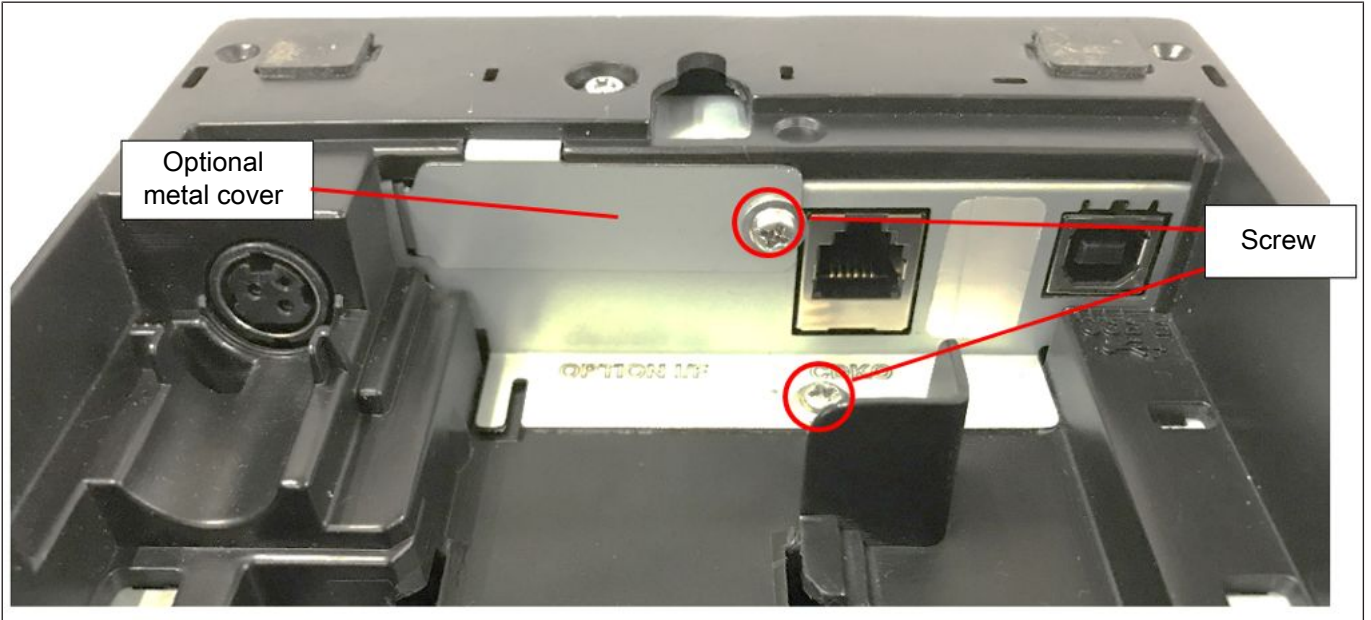

Serial Interface (RS232) Option

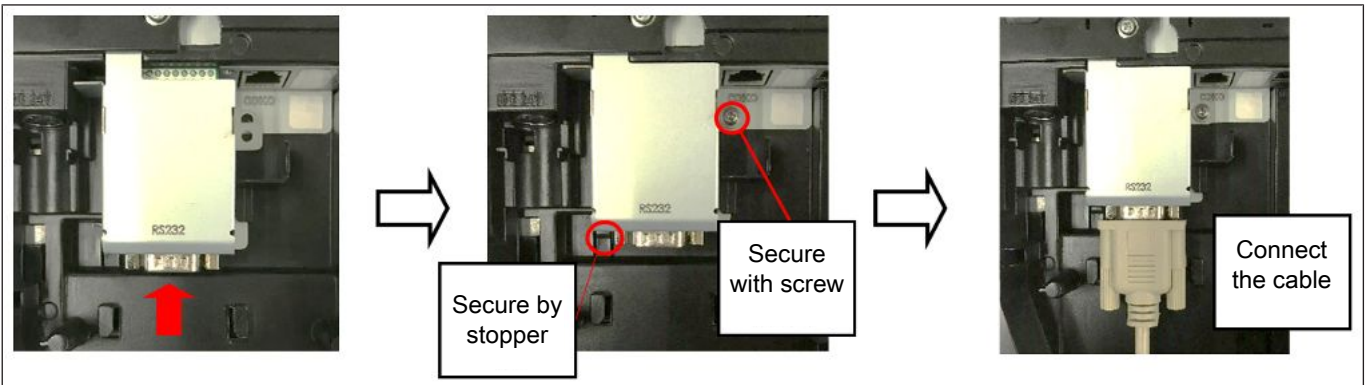

Ethernet Interface (LAN) Option

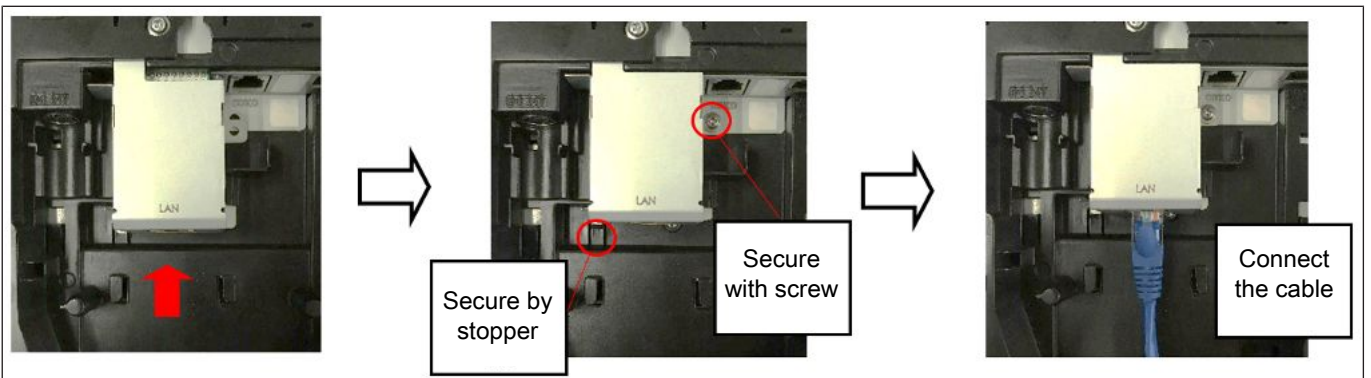

Power USB Option

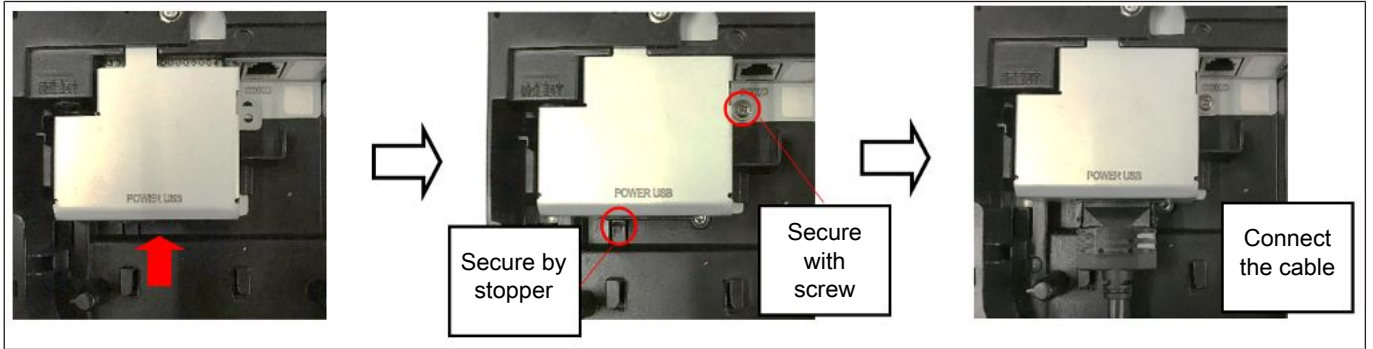

Disconnect Option Card (ALL Option Card)

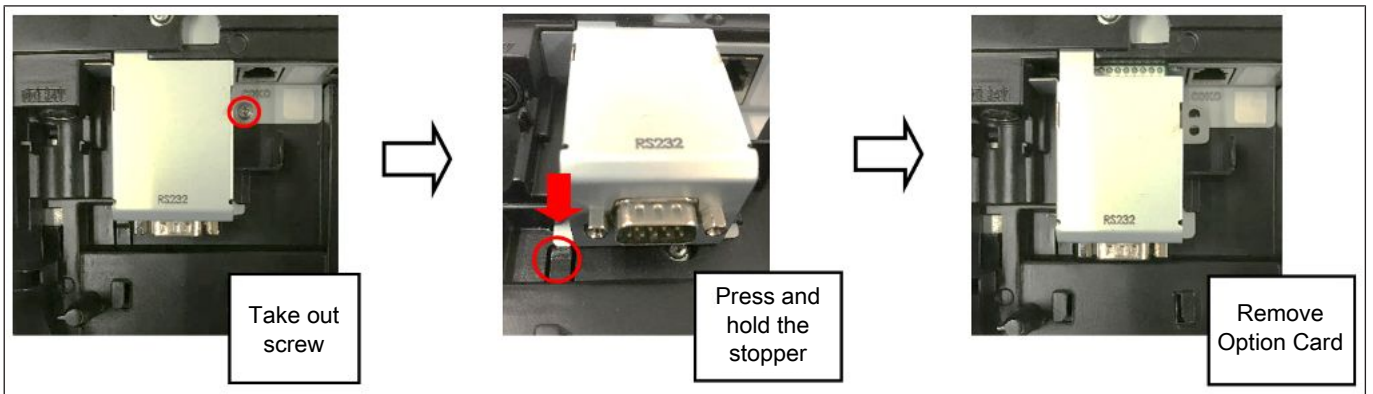

10.1.4 Connect via Y-Cable

Y-cable is an option to connect power connector and USB Type-B connector to POS terminal.

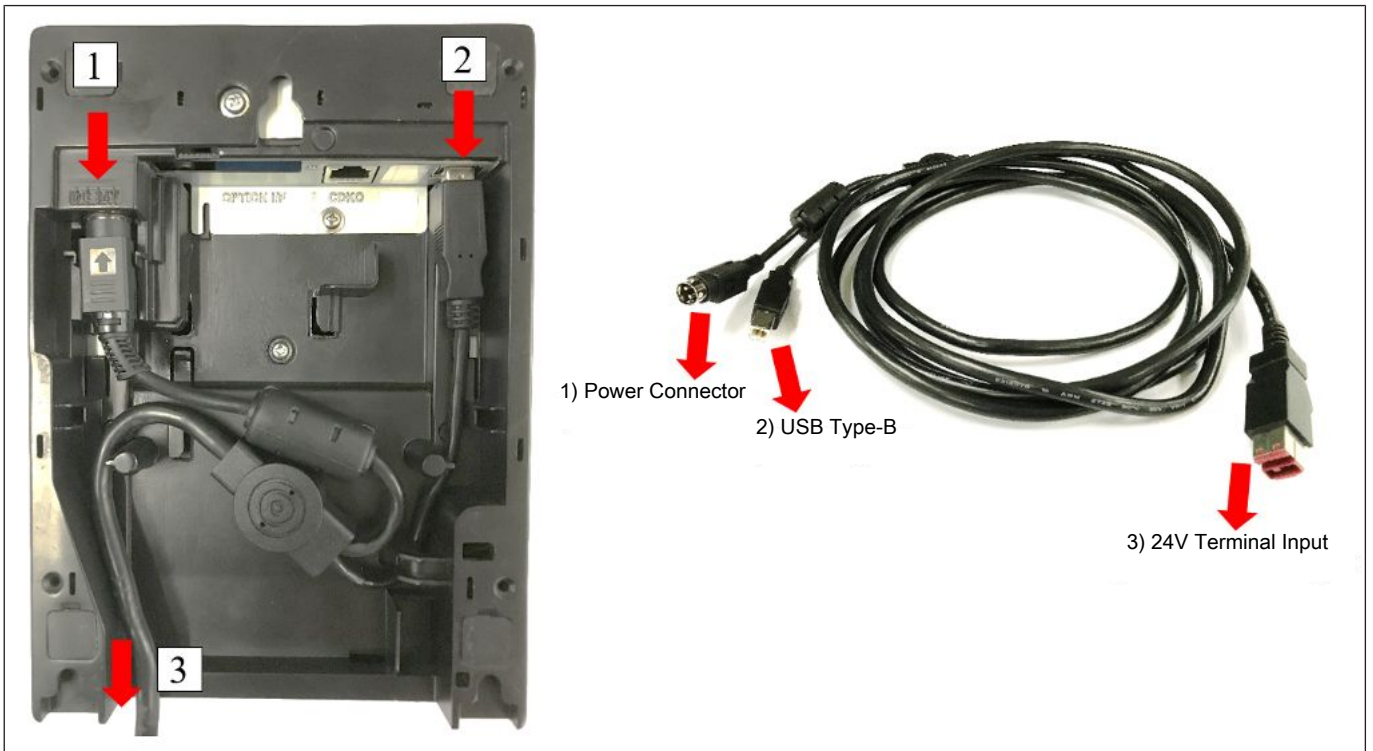

10.1.5 Connecting via Cash Drawer

- 1) Make sure that the printer does not connect to any power supply.
- 2) Connect the drawer cable to the drawer interface connector in the correct orientation.

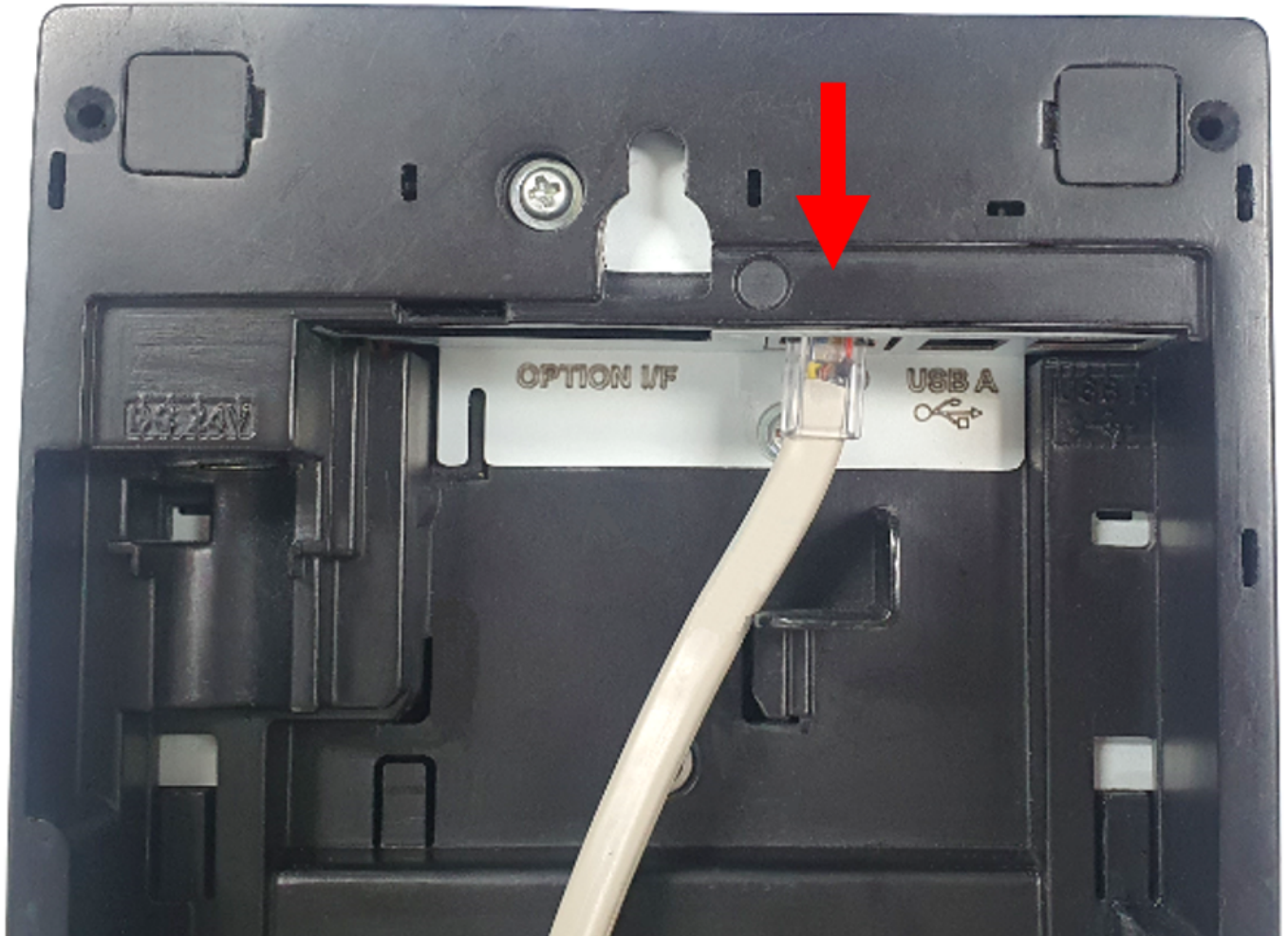

[Drawer interface connector] (6-pin modular connector)

A Drawer cable which connects the printer to a drawer is connected to this connector. To this connector, a Diebold Nixdorf drawer can be connected. Further information please refer to [Section 9](#)

10.1.6 Interface cable to POS terminal connection position

Connect the interface cable to the POS terminal, and then plug in the power cord to the AC outlet.

10.2 Choosing a Location

Table Top – Horizontal orientation

The POS printer takes up relatively little counter space and may be set on or near the POS terminal. Make sure that there is enough room to open the receipt cover for changing the paper roll. The paper will be presented in the top exit direction.



Wall Mounted – Vertical orientation



CAUTION

The wall mounting printer must be installed by **a qualified and professional installer** who is familiar with building construction methods, building materials, building codes, electrical codes, fire codes, and local laws governing public access areas.

There is a wide variety of types of wall construction, age and condition. After reviewing the conditions onsite, the installer must make the final judgment as to the suitability of the existing wall material to determine if additional bracing or supports are required. Attaching the screws involve making minor modifications to the building construction. Be sure to observe proper safety precautions to prevent injury. Unforeseen hazards, for example, natural gas and power lines, can exist when drilling and cutting into walls.

Screws are not included with the printer and must be supplied by the installer. The type of screws required are flat head metallic screws. Screw sizes can be referred at the figure below.

Mount the printer to a flat, sturdy, structurally sound column or wall surface. Before installing the wall mounting printer, ensure that all applicable building and electrical codes and accessibility requirements and guidelines are followed. Compliance with local building codes, electrical codes, and governing laws should take precedence over this set of instructions.

INSTALLATION PROCEDURE

The POS printer may be mounted on vertical wall. Make sure there is enough room to open the receipt cover to change the paper. Mount the screws on the wall using the following recommended mount dimensions. To fix the printer securely, install the screws on the wall made of **wood, concrete, or metal**. The thickness of the wall should be **10 mm (0.4")** or more. Be sure to use **flat head metallic tapping screws**. Make sure that the POS printer fix on the mounting heights of **2 meters and below**.

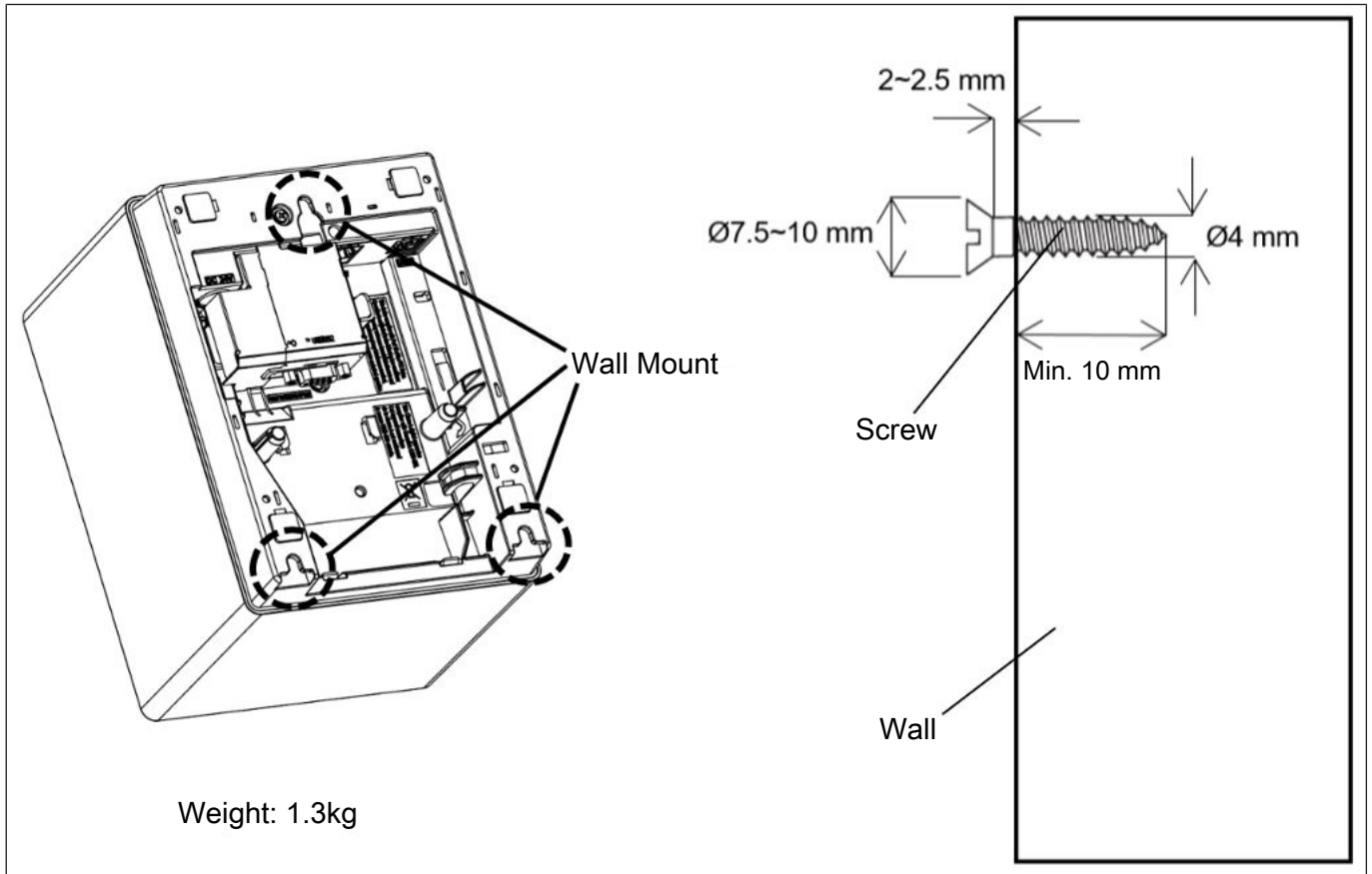

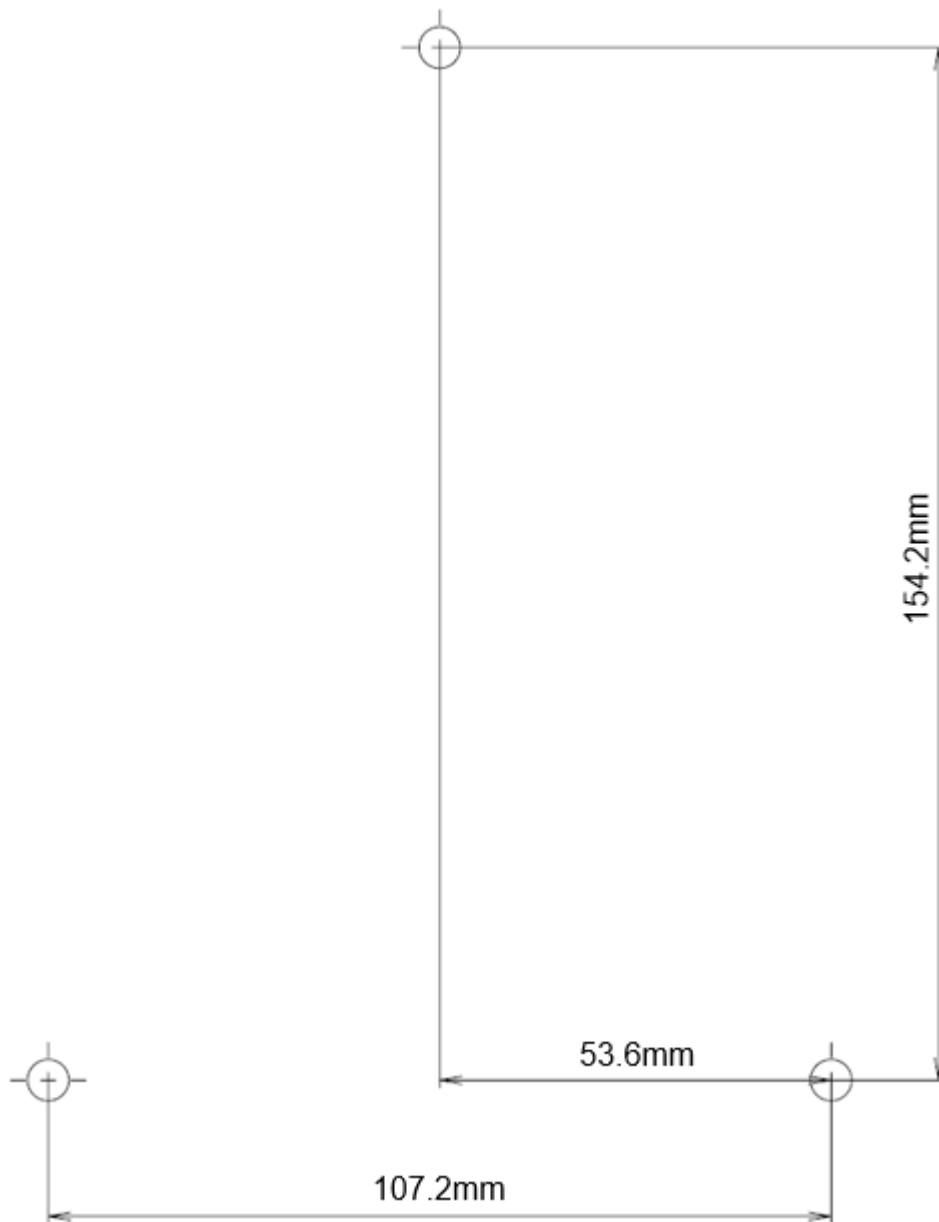







*This guide can be printed out in A4 size as a reference for the wall mount. Since printing A4 paper settings may vary across different printers, please measure and ensure the distances are the same as the dimensions stated before drilling the wall.

10.3 Loading the Paper Roll

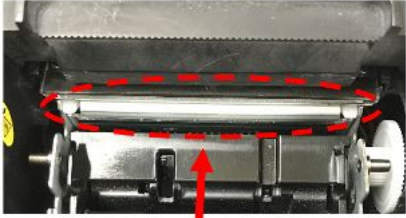
When you use the printer for the first time or when the receipt paper has been used up, load a paper roll following the procedures while the printer power is still connecting to power supply and is set to ON.

A POS printer prints thermal receipt paper by applying heat to the paper to react with the chemicals on the paper surface. Paper Low sensor and the LED blinking pattern will indicate that the paper roll conditions.

 WARNING		
 		<p>The print head becomes very hot while printing. Never touch the print head to avoid getting burned. Standard operating temperature of printer is 5°C to 50°C. Please do not operate out of range for safe operation.</p>
 		<p>Hazardous moving cutter. Keep fingers and other body parts away.</p>



CAUTION

1. Use only specified paper. **Use of non-specified paper may shorten the print head life resulting in problems with print quality, paper feed failure, or shorten the cutter life.**
2. Do not subject the thermal paper roll to water, oil, or heat source as this will darken the paper.
3. Load the paper roll in the correct orientation. Failure to do this may cause a paper jam error.
4. Care must be taken not to damage the print head and platen when the printer cover is opened as this may cause a poor print or a printer failure.
5. Do not open the printer cover while the printer is printing.
6. Do not hold the receipt while the printer is printing. Doing so may cause a paper jam.
7. When closing the printer cover, do not press it down too hard.
8. Do not put anything on the printer cover or push the cover too strongly. Doing so may cause a print failure.

Turn the printer power ON by connecting to power supply.

Pull up the cover open lever to open printer top cover.

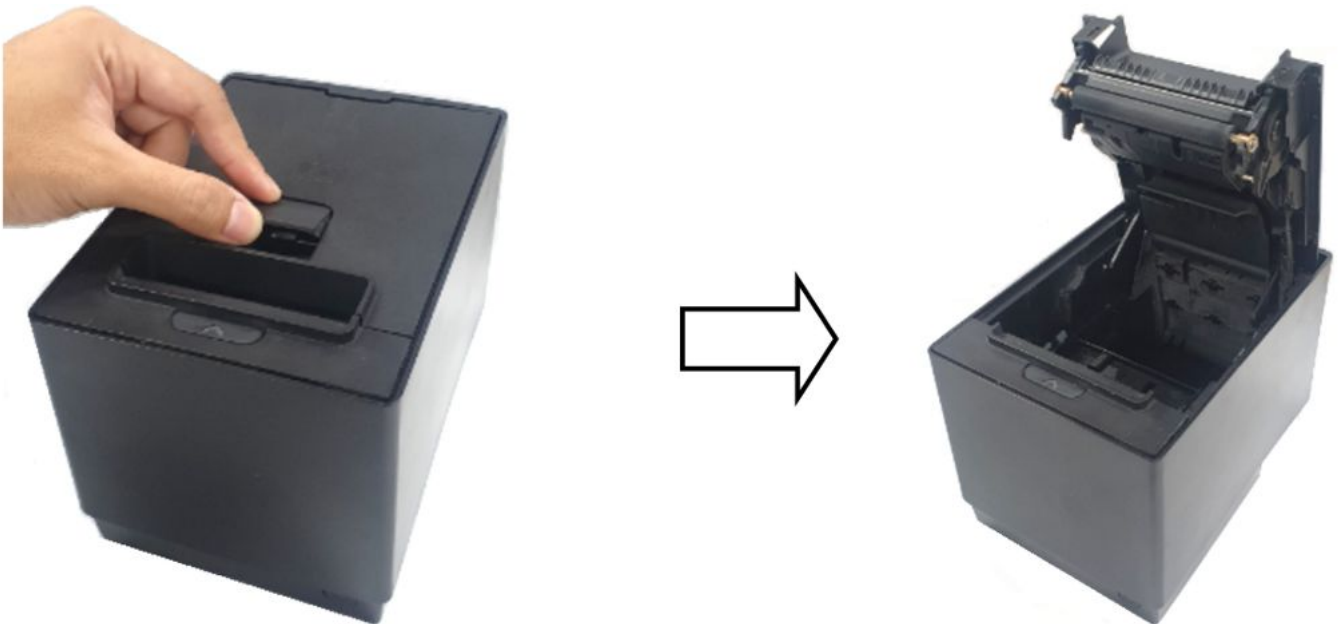

Check for the correct orientation of the paper roll (Thermal coated side facing print head), and load into the paper holder.

Pull the receipt until it extends over the paper outlet for about 5 cm.

Make sure the paper is laid within the paper guide before closing the top cover.



Horizontal Orientation

Close the printer top cover gently and printer will automatically perform auto cut.



Horizontal Orientation

Installing 58 mm paper guide (Sold separately)

To enable 58 mm print width, refer to 6.1 Offline Diagnostic, select “Paper Width” and select 58mm.

Insert the 58 mm paper guide to the slots located inside the left side of the printer.

Place the 58 mm paper roll inside and close the cover.

To remove the paper guide, simply press the latch to the right and pull it out.

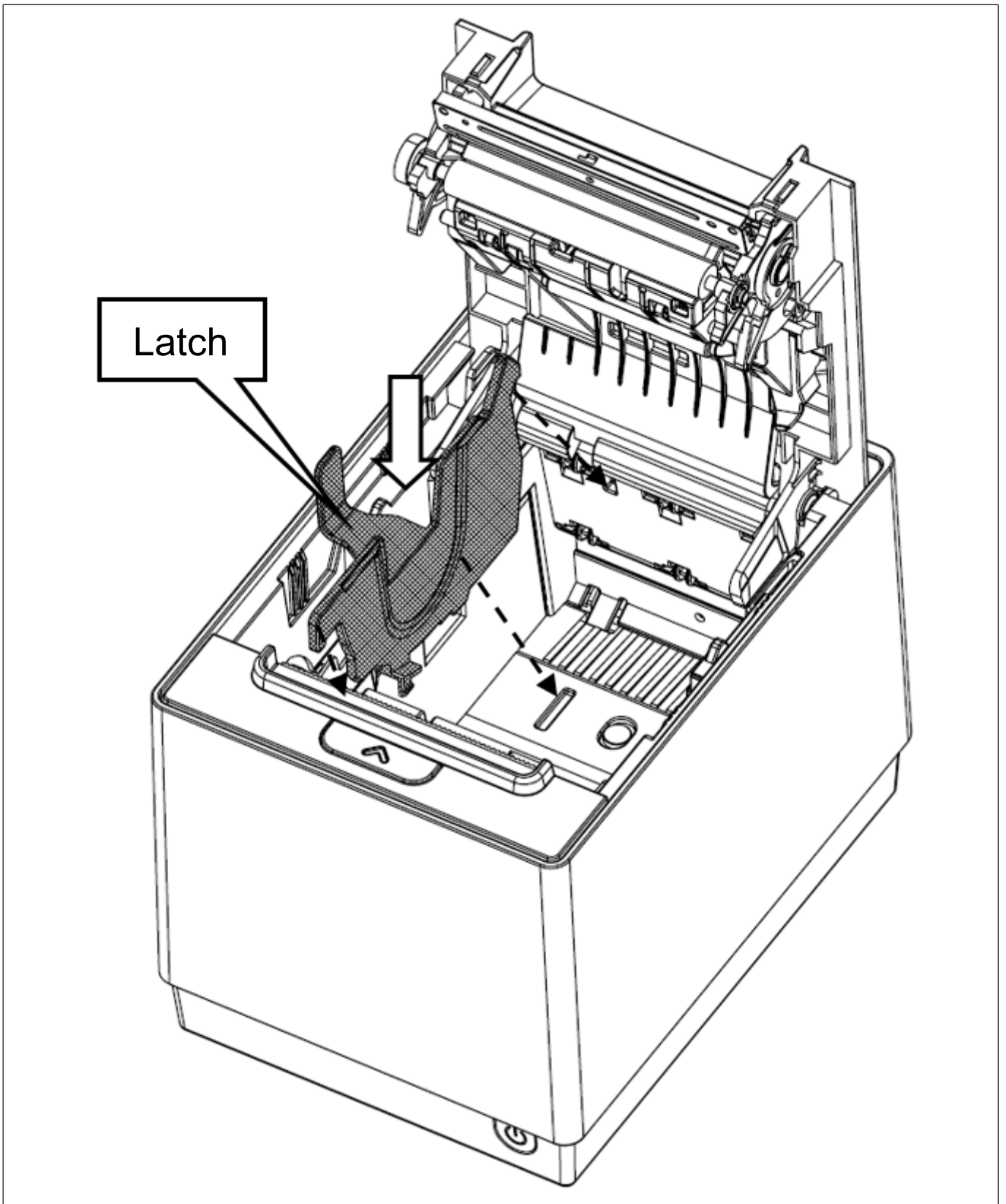

11 DIAGNOSTICS

11.1 Offline Diagnostic

To configure the software or hardware, follow these steps:

1. Open the Top Cover/Printer Door, and then check if the printer has paper.
2. Insert a paper roll if no paper is found.
3. Restart the printer while pressing the Paper Feed button.
4. The printer beeps, prints the service menu, and then waits for you to make a selection from the Main Menu on the printout.
5. The service menu can also be printed by pressing and holding the paper feed button while closing the top cover.

P1200 Printer

*** Service Menu ***

Exit/save → No Click

Print Self test → 1 Click

Diagnostic → 2 Click

Configuration → 3 Click

Information → 4 Click

5. Press or click the Paper Feed button based on the number of clicks associated to your desired option as stated on the Main Menu, then hold the button down for at least one second (2 tone beep sound) to validate.

Service Menu Structure – Main Menu

Once it enters offline diagnostic mode, it prints main menu as follow

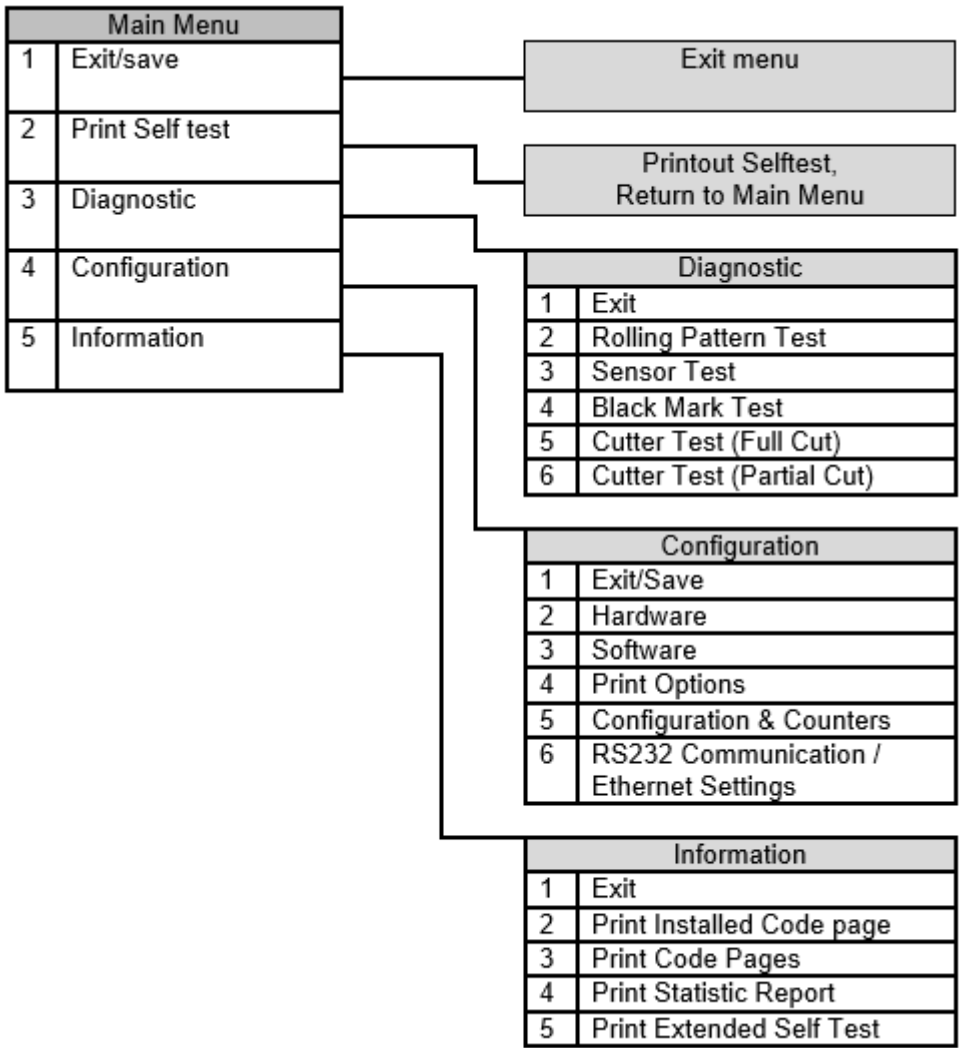

Main Menu / Diagnostic

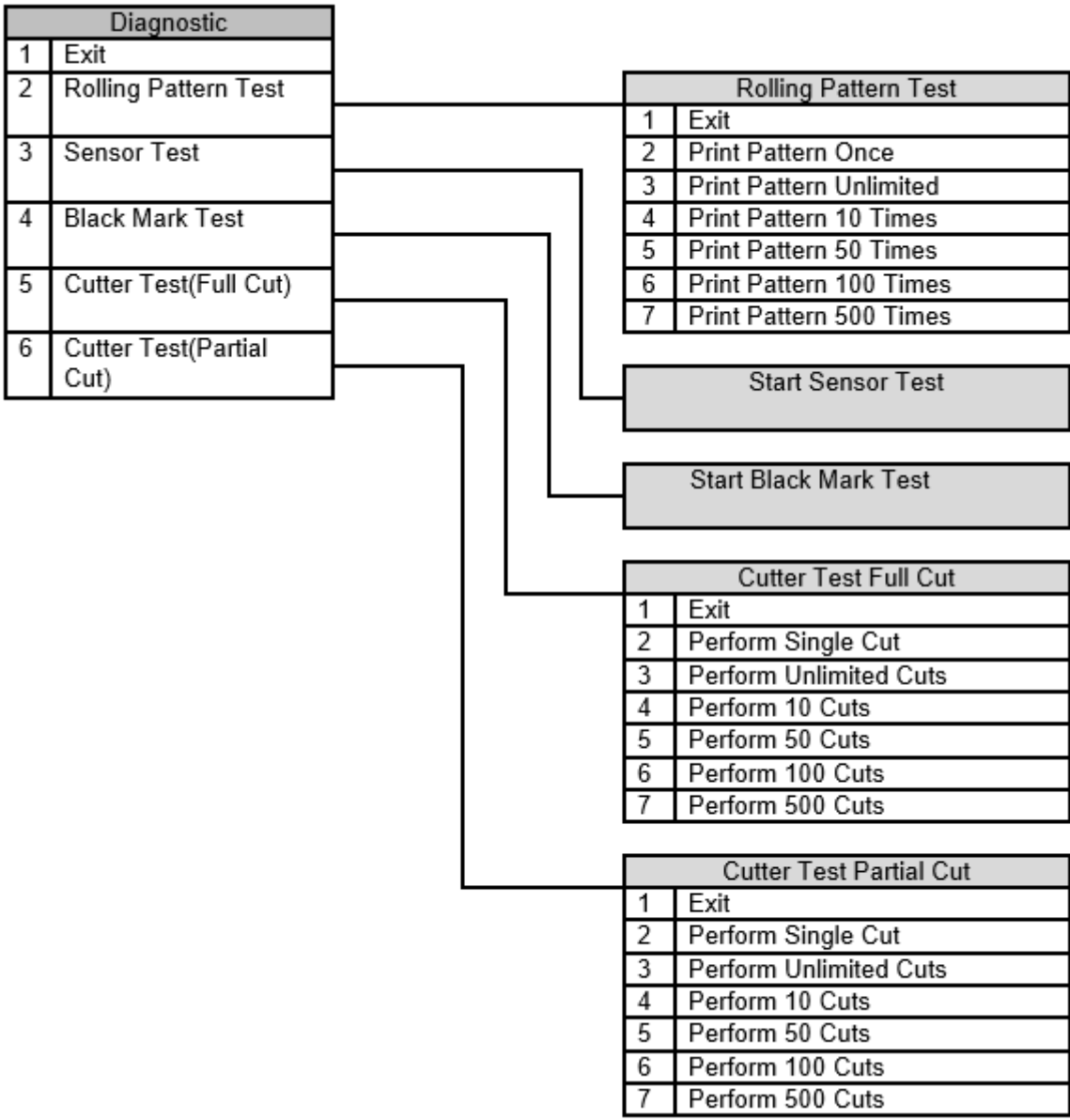

Main Menu / Configuration / Hardware

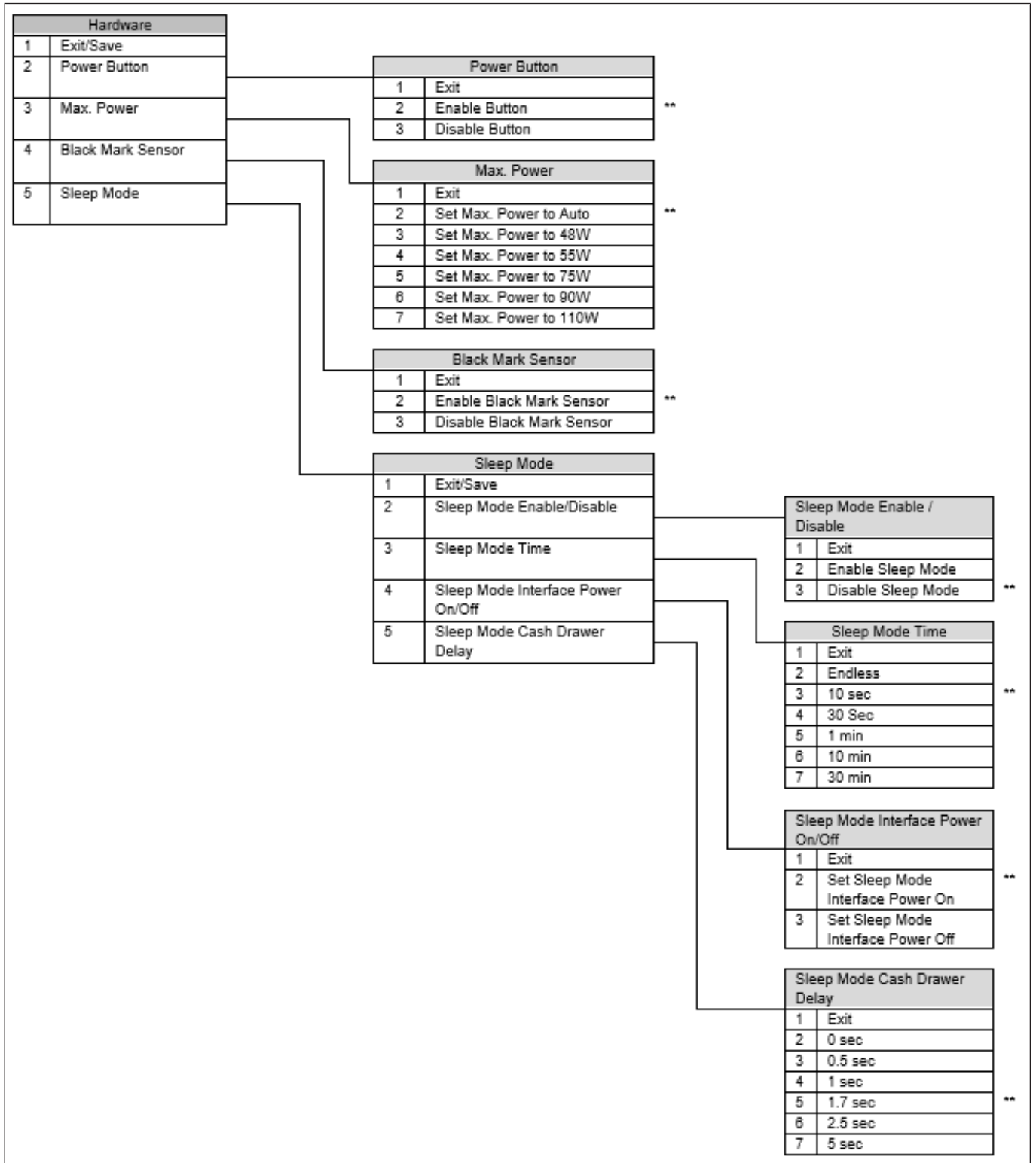

Main Menu / Configuration / Software

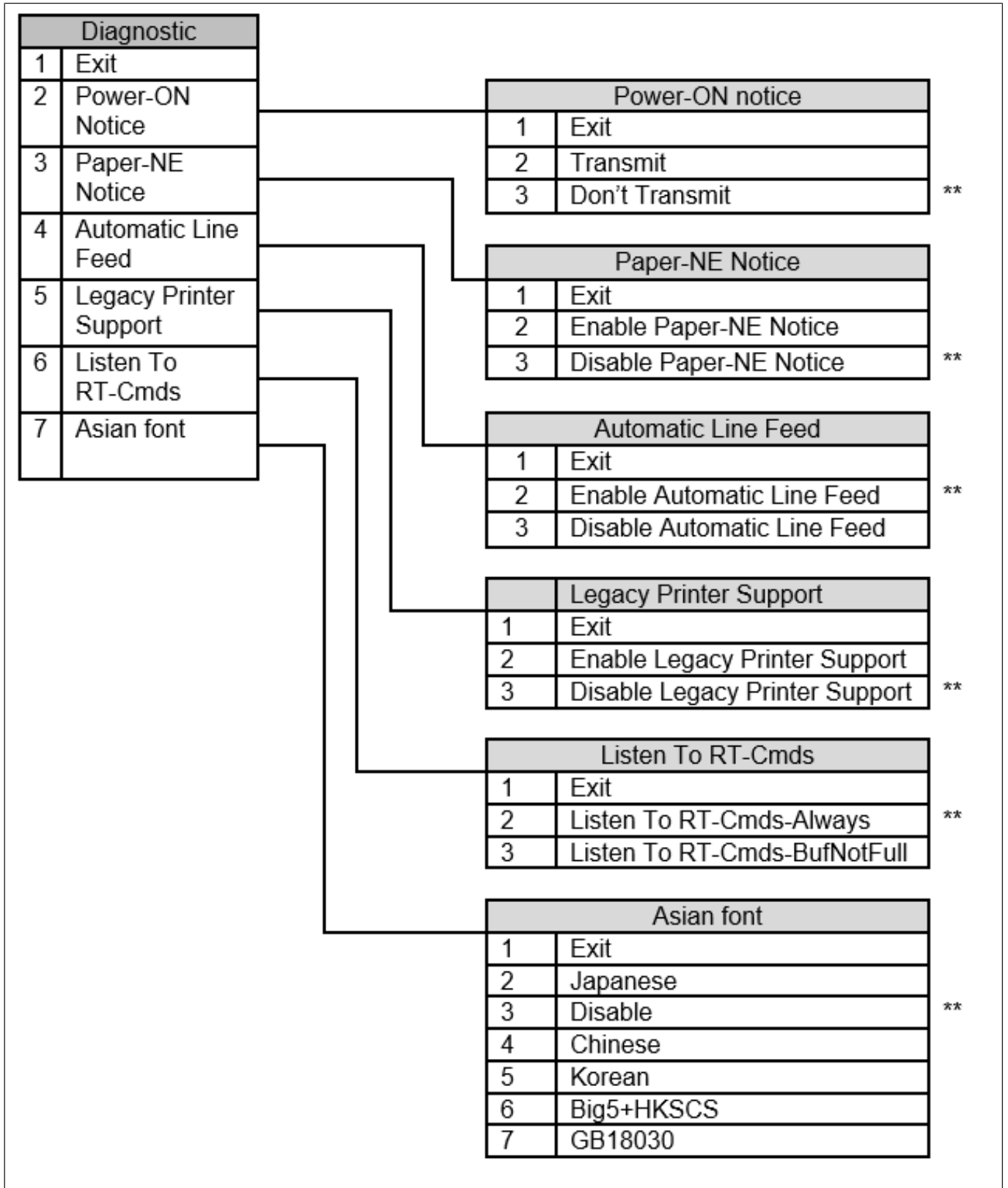

Main Menu / Configuration / Print Options

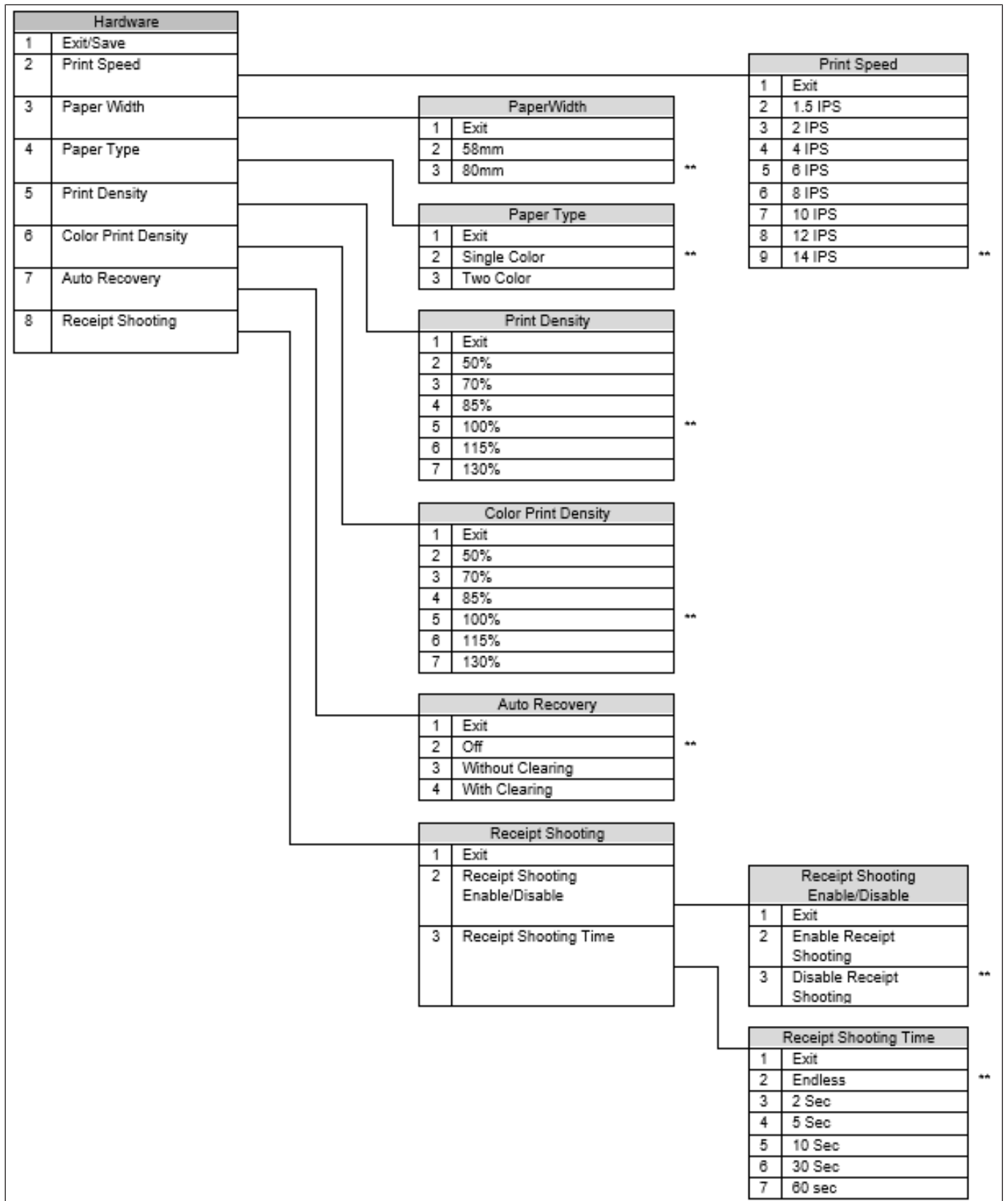

Main Menu / Configuration / Print Options

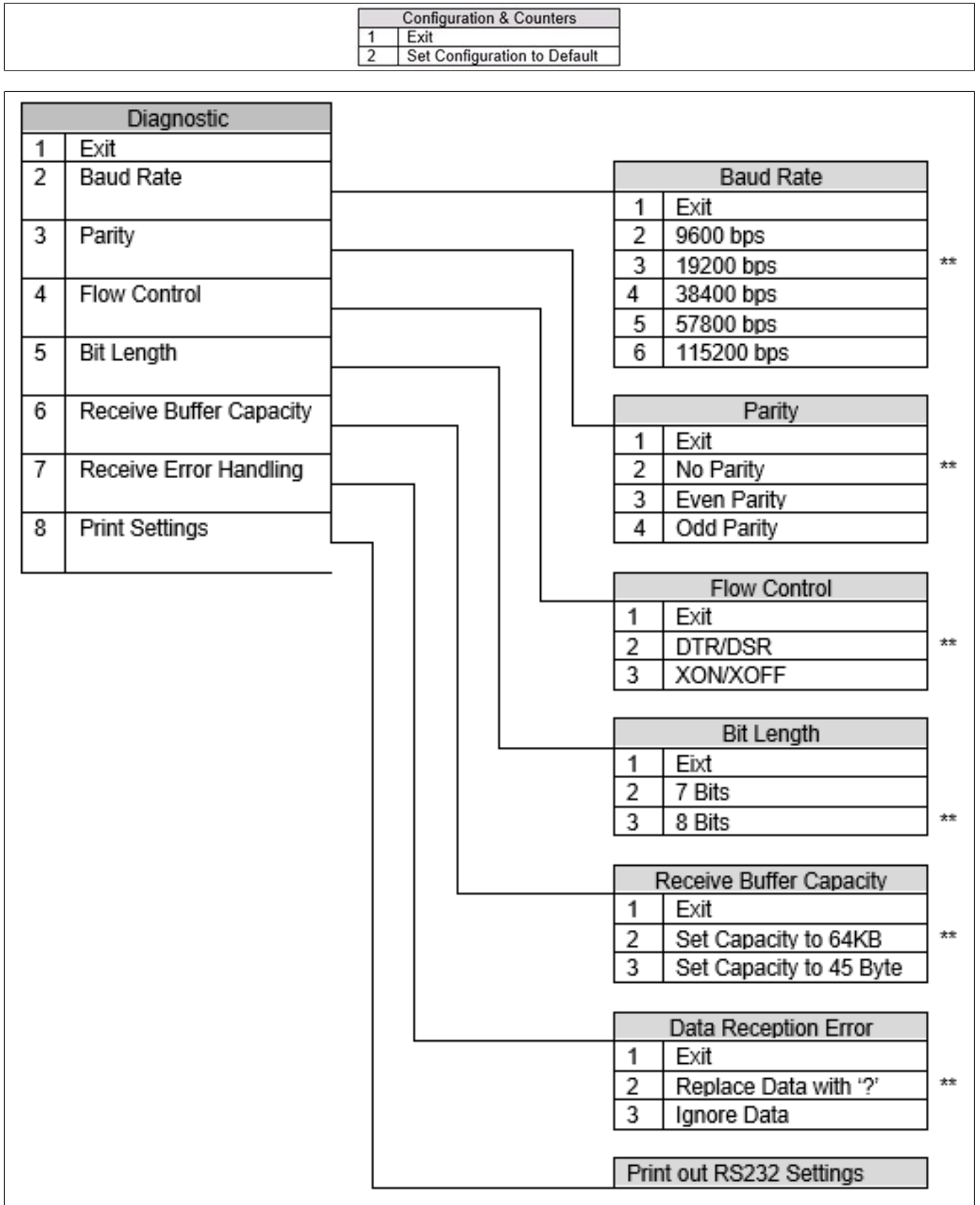

Main Menu / Configuration / Ethernet Settings

Diagnostic	
1	Exit
2	DHCP

Baud Rate	
1	Exit
2	Enable DHCP
3	Disable DHCP



12 GENERAL MAINTENANCE



WARNING

Be sure to disconnect the power cord prior to performing any maintenance.
DO NOT POUR WATER directly onto the printer, as this may cause electric shock or fire.
The print head becomes very hot while printing. To avoid getting burned, never touch the print head during the maintenance.



CAUTION

Do not use any sharp object to clean the print head and platen. Doing so may damage them, causing poor print or missing dots.
Never use an organic solvent like thinners or benzene for cleaning. Using such solvents may discolor the covers.
Do not touch the print head element as static built-up may damage the print head.

To help retain the high quality and performance of your printer it should be cleaned regularly. The greater the usage on the printer, the more frequent the cleaning. (i.e. low usage=weekly, high usage=daily)

12.1 Cleaning the Covers

Wipe the covers with a soft dry cloth or soft cloth slightly moistened with mild detergent. After using detergent for cleaning, be sure to wipe it off with a slightly moistened cloth.

12.2 Cleaning the Thermal Print Head



CAUTION

Do not spray or try to clean the thermal print head or the inside of the printer with any kind of cleaner as this may damage the thermal print head and electronics.
If the thermal print head appears dirty, wipe it with cotton swabs and isopropyl alcohol.



NOTE

The thermal print head does not normally require cleaning if the recommended paper grades be used. If non-recommended paper has been used for an extended period, cleaning the print head with cotton swabs and rubbing alcohol will not be of much benefit.

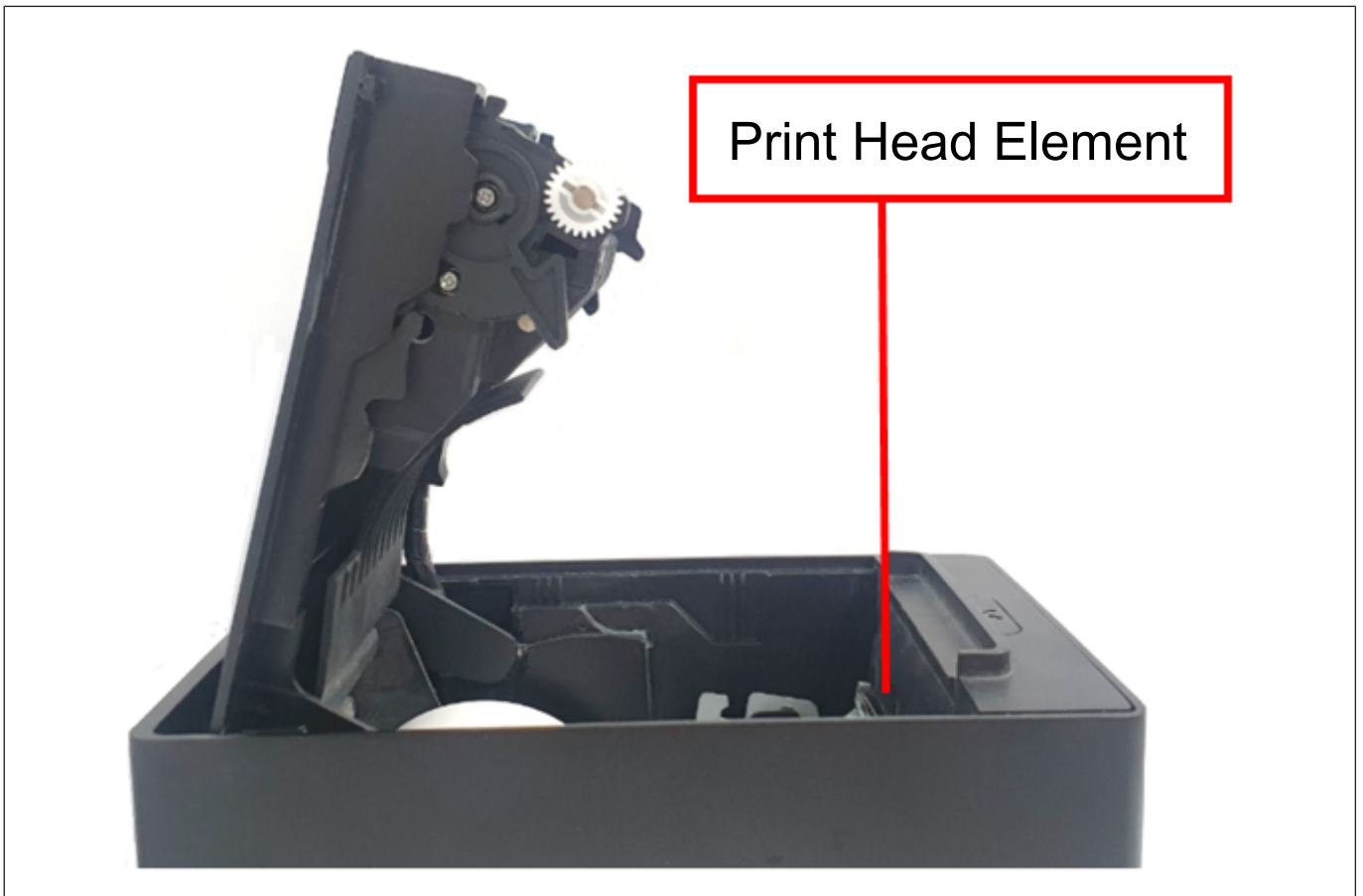

13 TROUBLESHOOTING



⚠ WARNING

If you cannot solve a problem with the following solutions, do not attempt to repair it by yourself.

Turn the power supply off, unplug the printer, and then contact your authorized Diebold Nixdorf representative for assistance.

13.1 Removing Jammed Paper

When printer is jammed, the LED will show Amber color with Five blinks and Pause for 5seconds.

Open the printer cover.

Remove the jammed paper. DO NOT USE any sharp implement or tool as these will damage the printer.



Re-load the paper roll. Refer to [Section 10.3](#)

Close the printer top cover and the printer will be ready to use.

13.2 Resetting Cutter Failure or Jam

When the cutter is jammed, the LED will show Amber color with 3 blinks and Pause for 5 seconds.



Open the printer front cover by pulling on the both sides as shown in the figure on the left.



Flip to fully open the front cover.



Flip to open the top cover.



Remove any jammed paper and paper roll out from the printer. **DO NOT USE** any sharp implement or tool as these will damage the printer.

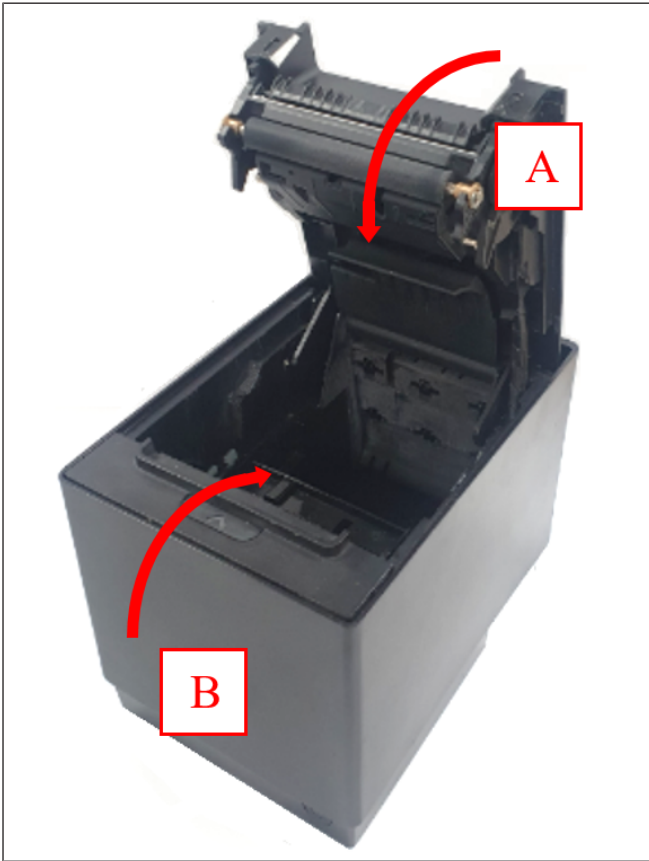

Close the printer top cover A first. Then, close the printer front cover B. The printer cutter will reset to the original position.

Then, re-load the paper roll. Refer to [Section 10.3](#) and the printer is ready to be use again.

13.3 Common Problems & Solutions

Power Supply Failure

Phenomenon	Cause	Check method	Solution
No power is supplied. (Power LED does not light.)	The power adapter DC cable is not connected to printer.	Check if the cable is connected properly.	Connect the specified power adapter DC cable to printer.
	The AC power cord is not connected to power adapter and wall outlet.	Check if the cable is connected properly.	Connect the AC power cord to power adapter and wall outlet.
	The wall outlet has problem.	If it is not a power failure, check if the power is supplied to the AC outlet with another electric appliance.	If not, contact your nearest power company.

Printing Failure

Phenomenon	Cause	Check method	Solution
Paper is not fed or is fed irregularly	The paper roll is not loaded properly	Check the paper roll if it is loaded properly.	Refer to Section 10.3 and load the paper roll properly
	The top or front covers is not closed properly	Check if the LED status (refer to Section 13.4 and the covers.	Close top cover and front cover properly.
	The paper is jammed	Check if the LED status (refer to Section 13.4 and whether the paper is jammed or torn and caught in the paper path.	Remove jammed paper from the paper path and set the paper properly.
No Printing when print job is sent from POS terminal	Interface cable is not connected properly	Check if the offline diagnostic printing work correctly. If yes, check the interface cable connection.	Connect the interface cable properly. Refer to Section 10.1.2
Void Printing (Paper comes out, but no characters are printed on the paper)	Wrong type of media inserted.	Check if the media is thermal.	Use the specified media.
	Paper Roll inserted wrongly.	Thermal coating should be in contact with printer head.	Insert correctly the paper roll. Refer to Section 10.3

Printing Failure

Phenomenon	Cause	Check method	Solution
Blurred or uneven print	Foreign object is attached to the print head.	Check whether any foreign objects are attached to the print head.	Clean print head with cotton swab or soft cloth slightly moistened with ethyl alcohol. Refer to Section 12.2
	Non recommended type of media loaded	Check if the media is of recommended type	Contact the Diebold Nixdorf's dealer for the recommended paper
	Faulty print head.	Check print head health if it is showing any warning dots. Refer to Section 6.4 "Printer Configuration Form"	Contact Diebold Nixdorf's dealer for service.

Cash Drawer Failure

Phenomenon	Cause	Check method	Solution
Cash drawer cannot be opened	The cash drawer cable is not connected properly	Check if the cash drawer cable is connected properly to the printer and cash drawer	Connect the cable properly. Refer to Section 10.1.5
	Incorrect cable is used	Check if the cable specification is meeting the requirement. Refer to Section 8.5	Use the cable which meets the specification.
	Cash drawer open function is not enabled in POS terminal	Check the setting in the POS terminal	Make sure the function is enabled in the POS terminal.

**NOTE**

If any problem occurs other than the above, please contact your authorized Diebold Nixdorf representative.

13.4 LED Indication Table

Printer Status	Color	Control	What to Do	Where to Go
Boot Up	ALL	RED ->AMBER -> GREEN		
Idle	GREEN	ON		
Printing	GREEN	ON		
Online Firmware Update	GREEN	Constant Blink		
IPL Firmware Update	GREEN to RED	Constant Blink		
Standby mode	GREEN	ON		
Unrecoverable error: in PCB block	RED	1 Blink Pause 5 seconds		
Unrecoverable error: in Thermal Head	RED	2 Blinks Pause 5 seconds		
Recoverable error: Thermal Head(Over Heat, Disconnected)	AMBER	2 Blink Pause 5 seconds	Wait for 10 seconds and the printer will resume printing	
Recoverable error: Cover Open	AMBER	3 Blinks Pause 5 seconds	Close the cover. The printer will not operate with the cover open.	
Recoverable error: Paper End	AMBER	4 Blinks Pause 5 seconds	Change the paper now. Do not run a transaction without paper as the data may be lost.	See Section 10.3
Recoverable error: Paper Jam	AMBER	5 Blinks Pause 5 seconds	Open the receipt cover, clear any jammed paper. Place the paper properly and restart the printer.	See Section 13
Recoverable error: Cutter Jam	AMBER	6 Blinks Pause 5 seconds	Open the receipt front cover first, then follow by top cover and check for the cutter.	See Section 13.2

TROUBLESHOOTING

			Clear any jammed paper you can see. Tear off any excess paper against the tear-off blade.	
Warning: Paper Low	GREEN	Constant Blink	Change the paper soon to avoid running out of paper part way through a transaction.	See Section 10.3



NOTE

If other LED status except for the above occurs, turn the power supply off, and then re-open. If this does not restore the LED, contact your nearest store representative for assistance.

14 APPENDIX

14.1 Ethernet

Ethernet interface is available when Ethernet option card is connected to printer.

14.2 Web Setting Page

Printer supports setting change via web page.

It requires "User name" and "Password" to login web setting page.

[IP]		
IP Address	<input type="text" value="192"/> <input type="text" value="168"/> <input type="text" value="1"/> <input type="text" value="99"/>	Value(0-255): Valid address
Subnet Mask	<input type="text" value="255"/> <input type="text" value="255"/> <input type="text" value="255"/> <input type="text" value="0"/>	Value(0-255): Valid Mask
Default Gateway	<input type="text" value="0"/> <input type="text" value="0"/> <input type="text" value="0"/> <input type="text" value="0"/>	Value(0-255): Valid address
DHCP	<input type="text" value="Enabled"/> <input type="button" value="v"/>	Select option
DHCP Request IP Address	<input type="text" value="0"/> <input type="text" value="0"/> <input type="text" value="0"/> <input type="text" value="0"/>	Value(0-255): Valid address
Host Name	<input type="text"/>	Maximum 16 character

IP Address : IP address for DHCP "Disable"

Subnet mask : Subnet mask setting

Default gateway : default gateway setting

DHCP : DHCP enable/disable option

DHCP request IP : IP address request for DHCP

Host name : Printer host name.

[TCP/UDP]		
Number of TCP Connections	<input type="text" value="6"/>	Value(1-6)
Time of Time-out (for Link Down)	<input type="text" value="120"/>	Value(1-120 minutes) : 0=No timeout
Time of Time-out (for Idle)	<input type="text" value="2"/>	Value(1-120 minutes) : 0=No timeout
TCP port	<input type="text" value="9100"/>	Value(1024-65535)
UDP port	<input type="text" value="3000"/>	Value(1024-65535)

Number of TCP connection : Maximum number of TCP connection

Time out. (link down) : Time out for TCP port close by Link down. (1-120 minutes)

Time out. (Idle) : Time out for TCP port close by idle. (1-120 minutes)

TCP port : Port number for TCP communication.

UDP port : Port number for UDP communication.

[Ethernet]		
MAC Address	00-80-91-e1-00-00	Unchangeable
Physical Layer	Auto <input type="button" value="v"/>	Select option

MAC address : MAC address.

Physical layer : Auto / 100Mbps full / 100Mbps Half / 10Mbps full / 10Mbps Half

[User/Password]		
User	admin <input type="text"/>	Maximum 16 character
Password	••••• <input type="text"/>	Maximum 16 character

User : User name to login web setting page.

Password : Password to login web setting page.

SNMP – Configuration

[Community]		
SNMP	Enabled <input type="button" value="v"/>	Select option
Read Only	public	Unchangeable
Read/Write	<input type="text"/>	Maximum 16 character

[SNMP Trap1]		
TRAP	Disabled <input type="button" value="v"/>	Select option
IP Address	0 0 0 0 <input type="text"/>	Value(0-255): Valid address
Community Name	<input type="text"/>	Maximum 16 character

[SNMP Trap2]		
TRAP	Disabled <input type="button" value="v"/>	Select option
IP Address	0 0 0 0 <input type="text"/>	Value(0-255): Valid address
Community Name	<input type="text"/>	Maximum 16 character

SNMP : “Enable”, “Disable” SNMP functionality.

Read/Write : Community name for SNMP.

TRAP 1 : “Enable” “Disable” for TRAP 1.

IP address : IP address for Trap 1

Community name : Community name for Trap1

TRAP 1 : Enable” “Disable” for TRAP 2.

IP address : IP address for Trap 2

Community name : Community name for Trap2

DIEBOLD NIXDORF

5995 Mayfair Road | North Canton, OH 44720 | United States

© 2021 Diebold Nixdorf, Incorporated. All Rights Reserved.

