

**BEETLE /moPOS Docking Unit,  
BEETLE /moPOS Single Charger**

We are interested in your opinion about this brochure.  
Please send us a message if you would like to provide constructive recommendations. For this, thank you in advance.

Best regards,

---

**Your opinion:**

Wincor Nixdorf International GmbH  
Documentation R&D SAT11  
Wohlrabedamm 31  
D-13629 Berlin  
Email: [retail.documentation@wincor-nixdorf.com](mailto:retail.documentation@wincor-nixdorf.com)

Order No.: **01750271256A**

# **BEETLE /moPOS Docking Unit, BEETLE /moPOS Single Charger**

**User Manual**

Edition June 2015

All other product names mentioned in this document may be the trademarks or registered trademarks of their respective owner.

**Copyright © Wincor Nixdorf International GmbH, 2015**

All rights reserved, especially for translation, reprint, reproduction by copying or similar processes, (in whole or part).. Violations shall give rise to damages.

All rights reserved, especially in the event of the awarding of a patent or utility model registration.  
Subject to availability and technical modifications.

# Contents

<b>Certification of the manufacturer .....</b>	<b>1</b>
Certified safety.....	1
Important Notes .....	1
Safety notes .....	2
<b>General information .....</b>	<b>4</b>
About this manual.....	4
Recycling of the system .....	4
Guarantee .....	5
Cleaning information .....	6
<b>Before switching on .....</b>	<b>7</b>
Unpacking and checking the scope of delivery .....	7
Installing the device .....	8
Install connection cable .....	9
Docking unit .....	9
Single charger.....	10
<b>Operation .....</b>	<b>12</b>
Plug the tablet in.....	12
Unlocking and removal of the tablet .....	14
Docking unit .....	14
Single charger.....	15
<b>BEETLE /moPOS Docking Unit .....</b>	<b>16</b>
Connections right .....	17
USB type B connection .....	18
12V DC in .....	18
Connections left .....	18
USB-A connections.....	19
Attendant key (optional).....	20
Status display .....	21
Operating status of the docking unit (DU) and POS device hub (PDH) .....	21
Error cases of the docking unit (DU) and the POS device hub (PDH).....	22

<b>BEETLE /moPOS Single Charger .....</b>	<b>24</b>
Status display .....	24
Display of the operating condition of the single charger (SC)...	24
Display of the fault cases of the single charger (SC).....	25
Power supply connection.....	26
<b>Technical data .....</b>	<b>27</b>
BEETLE /moPOS Docking Unit .....	27
BEETLE /moPOS Single Charger.....	27
<b>Abbreviations.....</b>	<b>29</b>

# Certification of the manufacturer



This device fulfils the requirements of EU Directive 2004/108/EC "Electromagnetic Compatibility" and 2006/95/EC "Low Voltage" Directive as well as RoHS 2011/65/EU.

For this, it bears the CE label on the rear side or the symbol is printed on the packaging.

## Certified safety



Your device is UL and cUL certified listed as accessory.

## Important Notes

The BEETLE /moPOS Docking Unit and/or the BEETLE /moPOS Single Charger are in accordance with the relevant safety regulations for data processing equipment.



Repairs to the device may only be performed by authorized specialized personnel. Improper repairs will lead to the loss of any liability claims.

Wincor Nixdorf International GmbH is not responsible for radio and TV emissions, which are created by unauthorized changes to the devices. In addition, cable or devices that are not authorized by Wincor Nixdorf must not be connected.

The user is responsible for disturbances that are created by the above.

## Safety notes

- Condensation may occur if this device is brought to the working area from a cold environment. The device must be absolutely dry before commissioning, therefore an acclimatization period of at least two hours must be observed
- The external power supply (for BEETLE /moPOS Single Charger) is equipped with a safety tested mains cable. Only a protective contact outlet grounded in accordance with the regulations can be connected. When installing the device, please ensure that the device plug appliance or the protective contact outlet are easily accessible.
- The device must be fully disconnected from the mains power when performing any work at the device and if inserting or removing data cables.
- Remove the power plug from the external power supply to completely separate the device from the mains voltage (BEETLE /moPOS Single Charger) or the PoweredUSB cable von of the BEETLE /moPOS Docking Station.
- USB devices may be connected to the docking unit or removed from the docking unit during ongoing operations if these devices comply with the specifications pursuant to [usb.org](http://usb.org).
- Before you begin any assembly work on the device, you should discharge yourself by touching a grounded object (e.g. a radiator).
- Please make sure that no objects (e.g. paperclips) are able to enter the inside of the device, as this may result in electrical shocks or short circuiting.
- During storms no data cables may be plugged in or unplugged.
- Protect the device from vibrations, dust, moisture and heat.
- Please guarantee the environmentally friendly disposal of used parts.
- In the event of emergencies (e.g. damaged housing or damaged power cable, penetration of liquids or foreign bodies), please switch the device immediately off, pull the power plug and inform the technical customer service of Wincor Nixdorf International GmbH or the authorized service partner of your dealer.



- Please ensure constructional and technical ambient conditions, which permit a flawless and efficient functioning. You should only connect the BEETLE /moPOS Single Charger or any other IT system to power supply networks with separate protective conductors (PE). This type of power supply network is called TN-S network. Do not use PEN conductors! Please also observe the recommendations of DIN VDE 0100 part 540, Annex C2. This will help you avoid any potential malfunctions.

# General information

## About this manual

The objective of this document is to aid you in the use of the system and also serve as a reference guide. To ensure a better readability, the term docking unit will be used instead of BEETLE /moPOS Docking Unit and the term single charger will be used instead of BEETLE /moPOS Single Charger in the following text.



Notifications are marked in the manual by this sign.



Attention notifications are identified by this sign.

As the type and scope of the application programs depend on the individual specific choice of each customer, this manual will not deal with any detailed issues pertaining to software.

Dedicated manuals are available for the peripherals that can be connected. Therefore, these devices will not be described in detail here. Please inform yourself by studying the respective manuals.

[http://www.wincor-nixdorf.com/internet/site\\_DE/DE/Support/Downloads/POSLotterySystems/Manuals/manuals\\_node.html](http://www.wincor-nixdorf.com/internet/site_DE/DE/Support/Downloads/POSLotterySystems/Manuals/manuals_node.html)

## Recycling of the system

Environmental protection does not only start during the disposal of systems, but already during their production. This product was designed in accordance with our internal standard "Environmentally friendly product design and development".

You are helping us for the recycling if you do not attach any labels to the device.

For materials, which currently cannot be used for a new purpose, Wincor Nixdorf International offers the environmentally friendly disposal in a recycle center, which is certified in accordance with ISO 9001 and ISO 14001.

If your BEETLE system can no longer be used, please send it to this environmentally friendly and contemporary form of recycling. Additional information about returns, recycling and disposal of our products can be obtained from your responsible branch office or from our recycle center in Paderborn.

Email: [info@wincor-nixdorf.com](mailto:info@wincor-nixdorf.com)

We look forward to your email.

## **Guarantee**

In general, Wincor Nixdorf (WN) guarantees a warranty of 12 months after delivery or acceptance date. This warranty covers all defects that occurred during normal use of the product.

Defects based on incorrect or inadequate maintenance, incorrect use or authorized changes at the product, and unsuitable location or an unsuitable environment are not covered.

All wear parts are also not covered by warranty.

More details about the warranty regulation can be found in your contract documents.

If a claim for warranty of the product does not exist and if you do not have a service contract with Wincor Nixdorf, then the Wincor Nixdorf Customer Care Center (CCC) is available for an order acceptance without a contract.

Phone: 0180 1 WINCOR (Vanity Number, subject to charge)

Phone: 0180 1 1 99 2 99 (subject to a charge)

Email: <mailto:WNCCC.contact@wincor-nixdorf.com>

## Cleaning information



Clean the docking unit or the single charger frequently with a dry, lint-free cloth. More severe contaminations are removed with a cleaning agent qualified for plastic surfaces, which can be ordered from WN.



Please ensure that the docking unit or the single charger is disconnected from electrical power during the cleaning and that no moisture penetrates the inside of the docking unit or the single charger.

# Before switching on

## Unpacking and checking the scope of delivery

Unpack the parts and check whether they correspond to the parts listed on the delivery note.

If the BEETLE /moPOS Docking Unit is delivered as a component of the BEETLE /moPOS Systems, then the cabling has been installed already at the factory. The connection cable and the unlocking key are located in a by-pack kit as a separate delivery unit. The by-pack kit of the BEETLE /moPOS Single Charger includes the external power supply and the unlocking key.

Should you detect any transport damages or inconsistencies between package content and the bill of delivery, please inform your contractual partner or sales outlet of Wincor Nixdorf International GmbH.

For this purpose, please provide the bill of delivery, the bill of delivery item and the serial number of the device.

The serial number is located on the rear of the docking unit or the single charger:

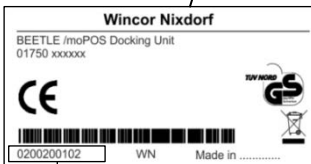
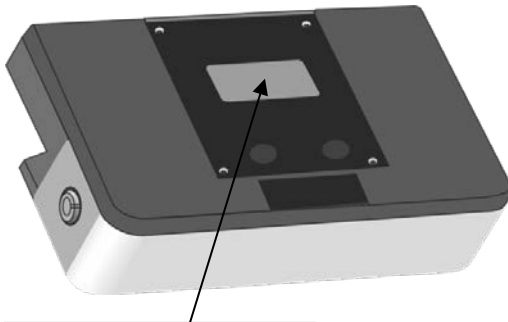

Serial number

We recommended keeping the original packaging for any subsequent transporting (protection against jolts and impact).

## Installing the device

Install the device in such a way that it is not subjected to extreme ambient conditions. Protect the device against vibrations, dust, moisture, heat and strong magnetic fields. The direct ambient temperature of the system must not exceed 35°C.

A VESA device is located at the rear. By selecting a suitable VESA bracket, you can position the docking unit or the single charger in such a way that you are able to read and operate the plugged-in tablet.

Each bracket can be arranged in such a way that adherence to the VESA75 standard is guaranteed. In combination with a VESA bracket at the BEETLE /moPOS Device Hub, the docking unit or the single charger offer an adjustable tilt angle to guarantee optimal readability at any time.

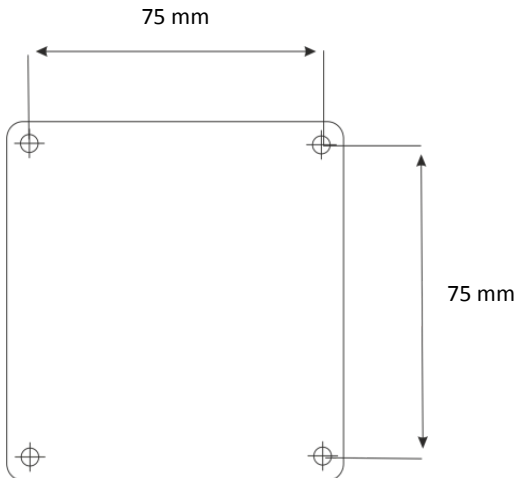

If the BEETLE /moPOS Docking Unit is delivered as a component of the BEETLE /moPOS system, then the bracket is already installed at the factory.

## Install connection cable

### Docking unit

Slide the right to cover on the rear of the docking unit to the outside.

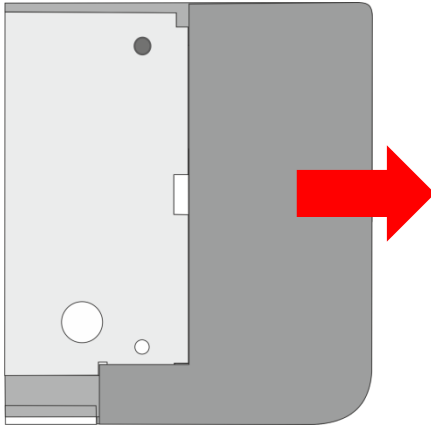

Plug the delivered cables or the Y cable into the specified sockets.

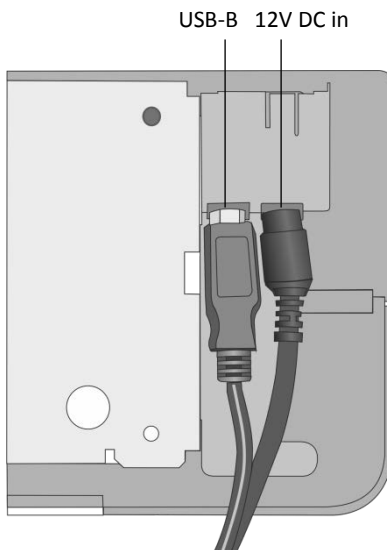

Place the cable in form of a loop to the right. Initially, place the ferrite in the right half of the housing. For this purpose, install the individual cable starting at the ferrite in the housing below and route it out of the cable output area. Place the cable loop onto the ferrite.

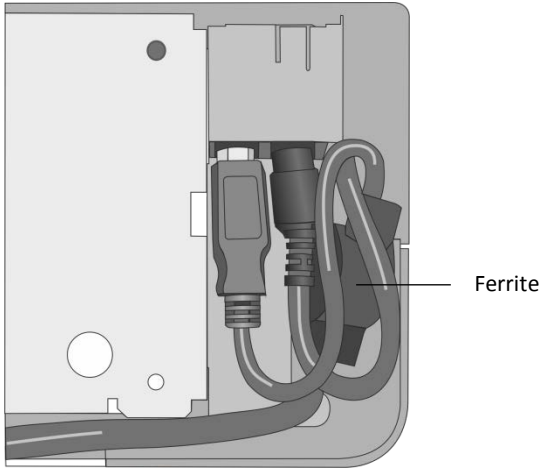

Close the rear by sliding the cover open.

### Single charger

Slide the left cover on the rear of the single charger to the outside.

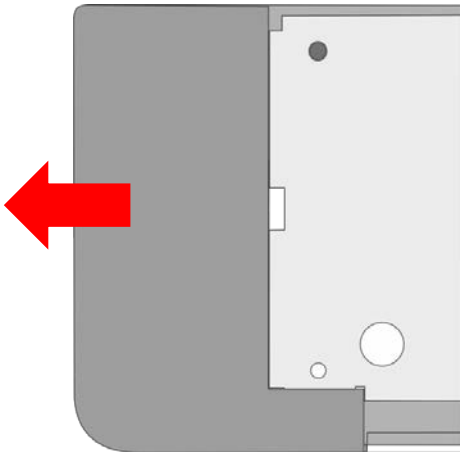



Plug the 12 v plug into the socket.

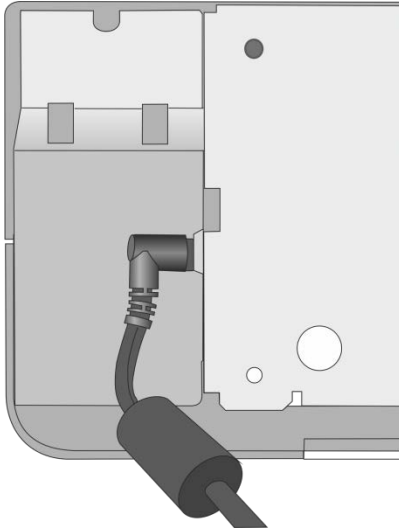

Install the cable between the plug and the ferrite in an arc. Route the cable in an arc to the cable output (see figure).

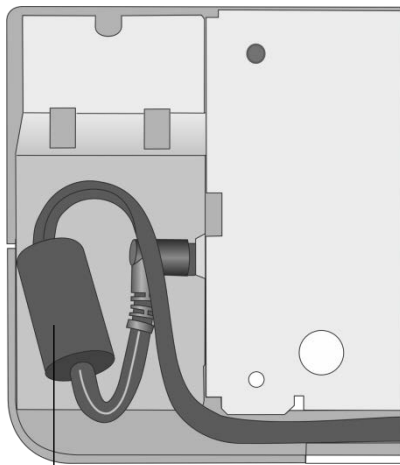

Ferrite

Close the rear by sliding the cover open.

# Operation

## Plug the tablet in

Follow this approach:

- Position the tablet in such a way that the connections at the underside of the table point to the connections in the charging bowl of the docking unit or the single charger.

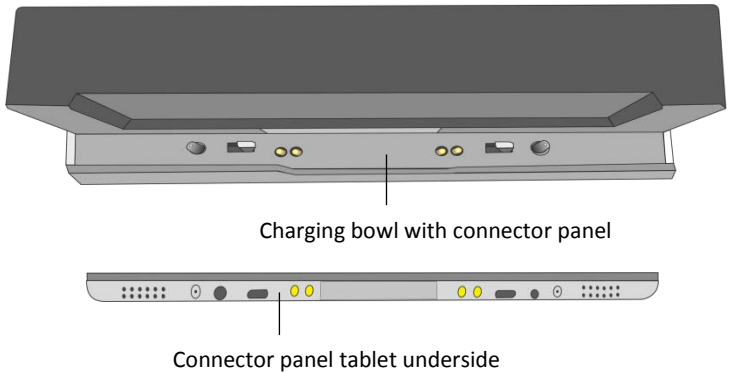

- Align the connections of the tablet and the docking station or the single charger centered to each other.
  - As shown in the following figure, slide the tablet carefully into the docking unit or the single charger until it latches in audibly.
-  Please ensure that the tablet does not have any attachments, such as wrist straps, that cover the connector panel or that obstructs the access.



- This automatically locks the tablet.

## Unlocking and removal of the tablet

### Docking unit

- The docking unit includes an electrical unlocking function. This function can be actuated through the software.
- Or unlock the lock on the right side by using the provided key.
- If an attendant's lock (optional) is available, then an unlocking by touching the magnetic lock can be triggered, assumed that the appropriate software support is available.
- Remove the tablet by pulling it centered at the upper edge upwards from the docking unit.

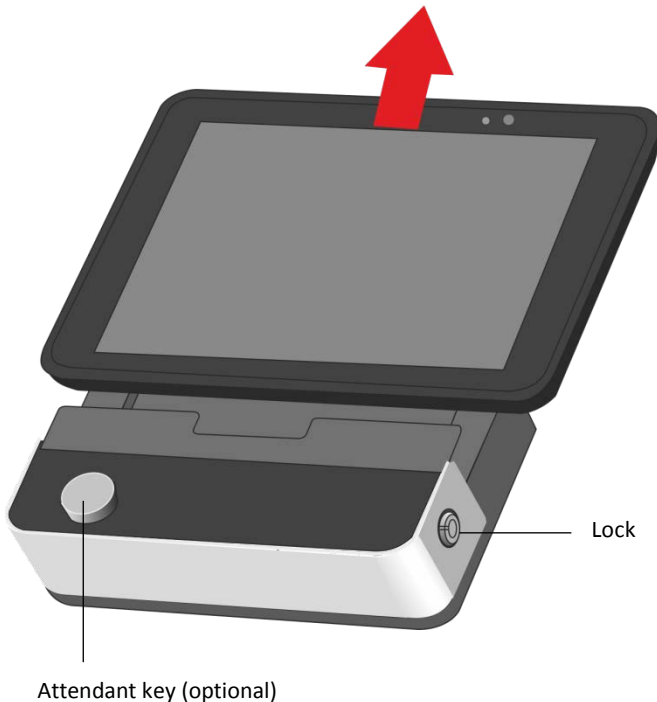

## Single charger

- Unlock the lock on the right side by using the provided key.
- Remove the tablet by pulling it centered at the upper edge upwards from the single charger.



# BEETLE /moPOS Docking Unit

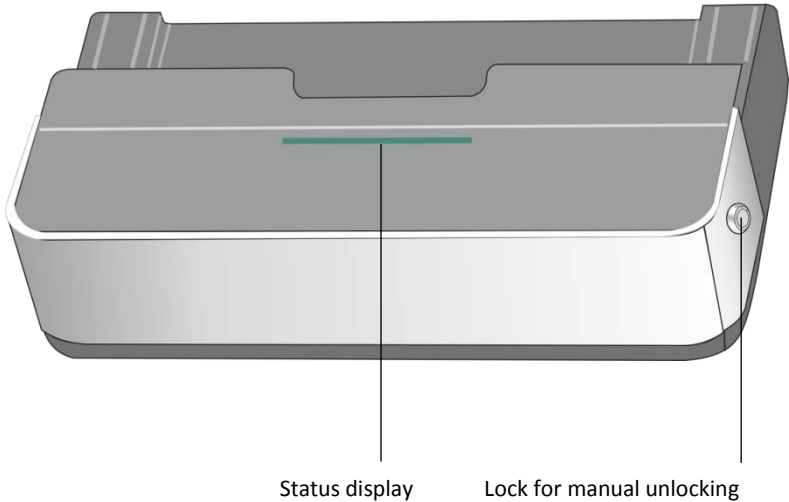

The front includes a receptacle fixture for a tablet and underneath a status display to display different operating states (see section "Status display"). The docking unit can house the BEETLE /moPOS 8.3" tablet as well as of the 10.1" tablet.

The docking unit keeps the tablet in a vertical position. It is used to charge the tablet and transfer data from the BEETLE /moPOS device hub to the tablet.

## Connections right

Slide the right cover on the rear of the docking unit to the outside.

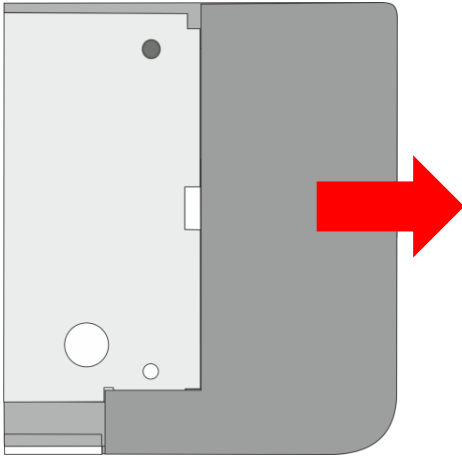

The following connections can be found underneath the cover:

USB-B 12V DC in

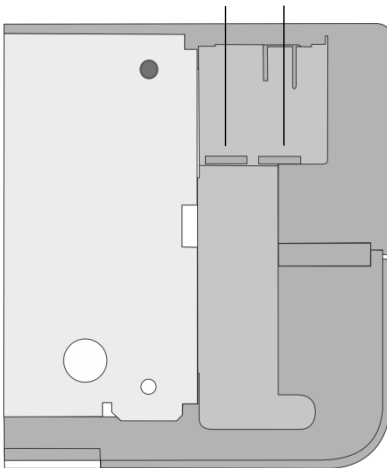

## USB type B connection

A USB-B connection can be found behind the right cable cover.  
The USB-B connection is a high USB plug:

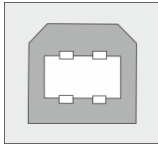

The USB-B connection establishes the connection to the BEETLE /moPOS device hub and must not be used for other connections.

## 12V DC in

The 12 V DC in socket can be found next to the USB connection.  
The connection to the BEETLE /moPOS device hub will be established with the USB cable through a Y cable.

## Connections left

Slide the left cover on the rear of the docking unit to the outside.

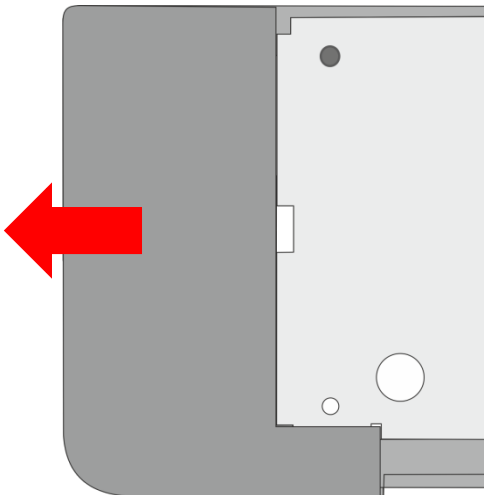



The following connections can be found underneath the cover:

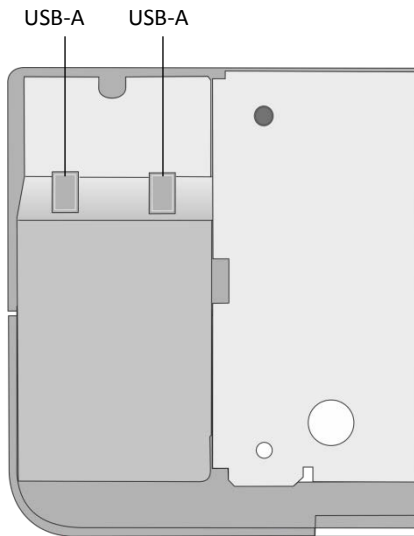

### **USB-A connections**

Several USB peripherals can be connected to these connections (USB-A), e.g. scanners, scales or dongles or even graphic cards or monitors. USB can provide the required power for devices with little wattage such as phones or keyboards.

## Attendant key (optional)

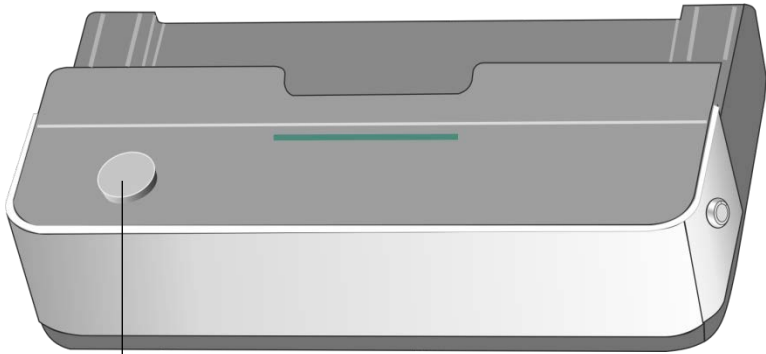





Attendant key

An attendant key is optionally located at the front of the docking unit. By touching with a magnet lock and availability of the appropriate software support, the electrical unlocking can be triggered, which means that the tablet can be removed from the docking unit.

## Status display

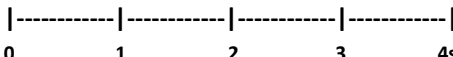
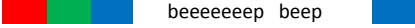
Through a multi-color LED display panel, the status display provides a fast overview for several states of the docking station, which is mounted on a BEETLE /moPOS device hub.

### Operating status of the docking unit (DU) and POS device hub (PDH)

Status	Color interval 
The LED stays switched off, because the DU is not supplied with electricity.	
During the switch on, the color changes from red to green to blue, afterwards, the device issues a signal sound to enable the user to review the operability of the LED and the beeper.	
Initially, the LED flashes blue for a short time, later a little longer during booting of DU and PDH.	
The LED lights permanently in green if DU and PDH are ready for operation. No tablet access to the PDH or it is plugged in the DU.	
The LED lights permanently in red if a tablet accesses the PDH (via Wi-Fi) or if it is plugged into the DU.	
The LED flashes slowly in the red, if a tablet is physically in the DU, however, it is not locked, e.g. if the tablet is not released for the use in the moPOS system or unlocked	

<p>through the software.</p> <p>⇒ The tablet is not locked and should be removed to protect against theft.</p>	
--	--

### Error cases of the docking unit (DU) and the POS device hub (PDH)

Status	Color interval
	<p style="text-align: center;">0                      1                      2                      3                      4sec.</p>
<p>The LED does not appear because DU and/or PDH are not supplied by electricity or if the connection from DU to PDH was disconnected.</p> <p>⇒ Check the power supply and the connection of DU to PDH.</p>	
<p>The LED flashes briefly twice in blue, if DU and/or PDH could not complete the boot process, e.g. because the USB connection between PDH and DU was disconnected.</p> <p>⇒ Check the power supply and the connection of DU to PDH.</p>	
<p>The LED flashes quickly in red, an interval cannot be identified if the PDH is not ready for operation because a firmware update is performed.</p> <p>⇒ Wait until the firmware update has been completed. The PDH restarts the system.</p>	

<p>The LED flashes quickly in red, an interval cannot be identified if the PDH is not ready for operation because a fault in operation could not be resolved.</p> <p>⇒ Restart the system. Inform your administrator if the fault appears again.</p>	
--	---

Additional flashing codes (white, green, multicolored flashing) can be found in the document "BEETLE /moPOS- End Users Guide – Getting Started".

# BEETLE /moPOS Single Charger

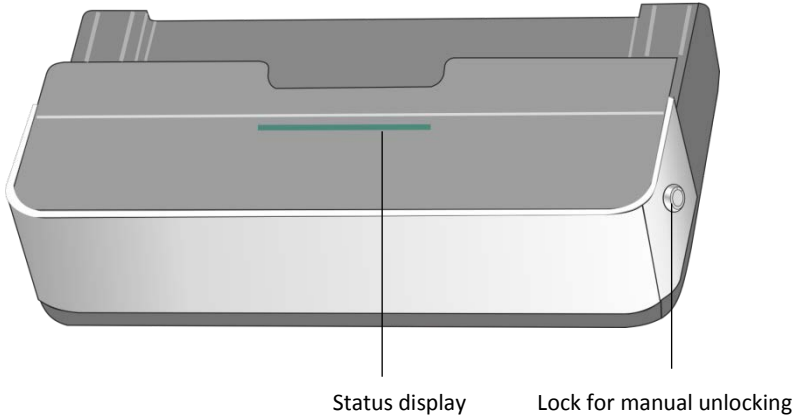



The front includes a receptacle fixture for a tablet and underneath a status display to display different operating states (see section "Status display").

The single charger can house the BEETLE /moPOS 8.3" tablet as well as of the 10.1" tablet and it keeps them in position. It is used to charge the tablet.

## Status display

### Display of the operating condition of the single charger (SC)

Through a two-color LED display panel, the status display provides an overview about the states in the docking station.

Status	Color interval  ----- ----- ----- -----  0 1 2 3 4sec.
The LED lights permanently in green if the ESC is ready for operation and if no tablet is locked into it.	
The LED lights permanently in red if the ESC is ready for operation and if a tablet is locked into it. The charge current can flow. Please check the charge contacts and the tablet if the charging display of the tablet does not display the charging process.	
The LED stays switched off, because the DU is not supplied with electricity.	

### Display of the fault cases of the single charger (SC)

Status	Color interval  ----- ----- ----- -----  0 1 2 3 4sec.
<p>The LED remains switched off while a tablet is locked in the SC and if the tablet cannot be charged, e.g. because the SC has no power supply or if the internal poly fuse has triggered a short circuit.</p> <ul style="list-style-type: none"> <li>⇒ Disconnect the device from the power supply, if required, resolve the short-circuit</li> <li>⇒ Reestablish the power supply.</li> <li>⇒ If the fault still exists, then the SC must be exchanged.</li> </ul>	

## Power supply connection

Use the power supply, which was part of the scope of delivery for the docking station, to supply the tablet with electricity and to charge the battery.

The connection is located underneath the left cover on the rear of the single charger.

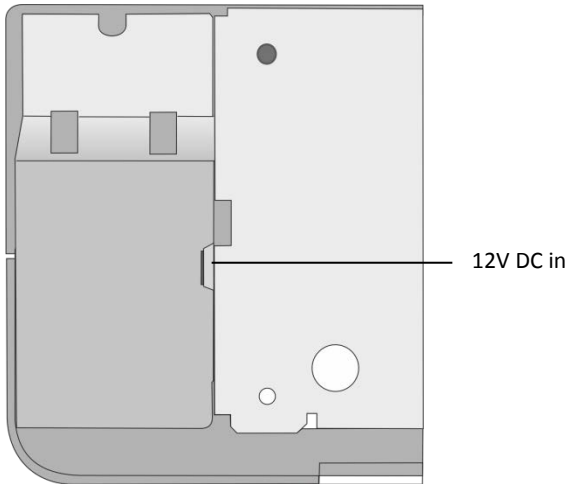



# Technical data

Ambient temperature	
Operation	+ 5 °C to + 35 °C
Transport	- 25 °C to + 60 °C
Storage	+ 5 °C to + 40 °C

## BEETLE /moPOS Docking Unit

Connection	12V powered USB
Input voltage	12V Direct current
Current consumption	max. 3A
Charge tablet	12V/2A
Read tablet ID	yes
Read battery status	yes
Locking	Automatic
Unlocking	Motor or key
VESA connection panel	75 mm x 75 mm
Status display	yes
Attendant key option	yes
USB connection (USB-A 2.0)	2

## BEETLE /moPOS Single Charger

Connection	12 V plug power supply
Input voltage	12V Direct current
Current consumption	max. 3A
Power supply FSP040	100-240V, 1.3A, 50-60 Hz
Charge tablet	12V/2A
Read tablet ID	No
Read battery status	No
Locking	Automatic
Unlocking	Key

VESA connection panel	75 mm x 75 mm
Status display	Yes
Attendant key option	No

# Abbreviations

A	Ampere
CE	European conformity symbol
cUL	Canadian Underwriters Laboratories
DC	Direct Current
DIN	Deutsches Institut für Normung (German Institute for Standards)
EG	European Community
EU	European Union
ID	Ident number
ISO	International Organization for Standardization
LED	Light Emitting Diode
PEN-Leiter	Protective Earth Neutral conductor
POS	Point Of Sales
TN-S	Terre Neutre- Separé
UL	Underwriters Laboratory (standards)
USB	Universal Serial Bus
V	Volt
VDE	Association of Electrical Engineering, Electronics and Information Technology e.V.
VESA	Video Equipment Standards Association
W	Watt
Wi-Fi	Wireless Fidelity
WN	Wincor Nixdorf International GmbH



Wincor Nixdorf International GmbH  
D-33094 Paderborn

Order No. / Bestell-Nr.: **01750271256A**